

brother

Embroidery Design Guide
Stickmuster-Katalog
Guide de motifs de broderie
Borduurontwerpen bedieningshandleiding
Guida ai ricami
Guía de diseños de bordado
Guia de desenhos de bordado
Руководство по дизайнам для вышивания

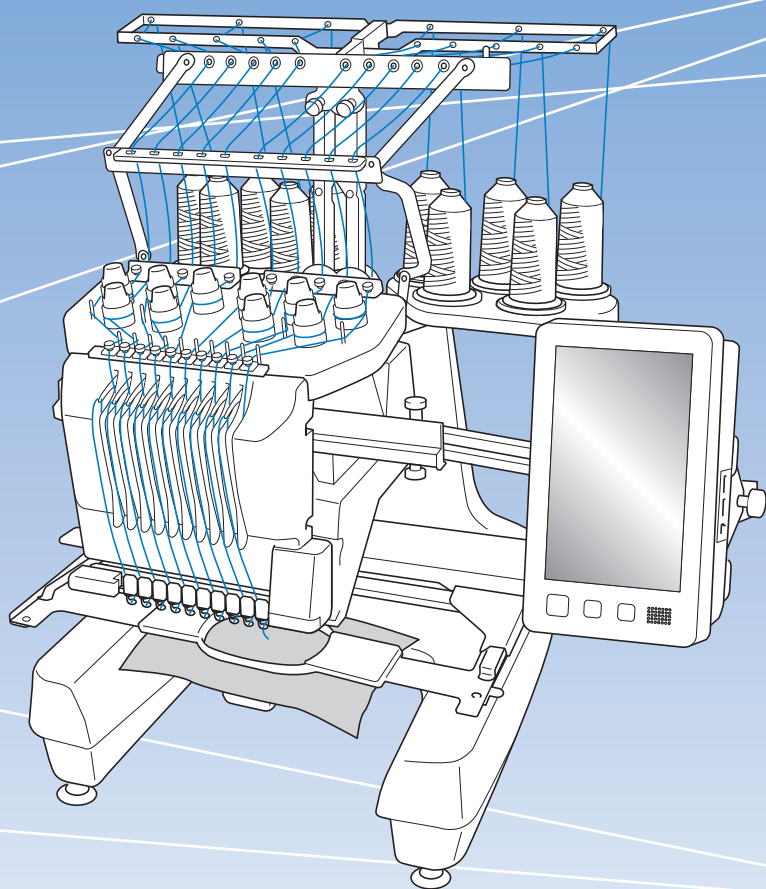

Note

Embroidery time and size of each design in this guide may differ from the information on the machine display. Please use as a reference purpose only.

Hinweis

Die Stickzeit und die Größe jedes Designs in dieser Anleitung können von den Informationen im Display abweichen. Bitte verwenden Sie die Angaben nur als Referenz.

Remarque

La durée de broderie et la taille de chaque motif présenté dans ce guide peuvent différer des informations affichées à l'écran de la machine. Merci de les utiliser à titre de référence uniquement.

Opmerking

De informatie in deze handleiding over de borduurtijd en de afmeting van het borduurpatroon kan afwijken van de weergave op het beeldscherm van de machine. Gelieve de informatie alleen te gebruiken als richtlijn.

Nota

Il tempo di ricamo e le dimensioni di ciascun ricamo in questa guida possono differire dalle informazioni sul display della macchina. Si prega di utilizzare solo come riferimento.

Nota

El tiempo de bordado y el tamaño de cada diseño en esta guía pueden diferir de la información en la pantalla de la máquina. Por favor, use solo como referencia.

Nota

O tempo e o tamanho do bordado de cada desenho neste guia podem ser diferentes das informações exibidas na tela da máquina. Use apenas com propósito de referência.

Примечание

Время вышивания и размер каждого дизайна в этом руководстве может отличаться от информации на дисплее машины. Используйте эти данные только для справки.

Contents

Summary of Embroidery Patterns	3
Pattern type selection screen	3
Embroidery Patterns	3
Frame Patterns	5
Utility embroidery patterns / Large buttonhole patterns	6
Monograms	7
Character patterns	8
Decorative Alphabet Patterns	19
Quilting border patterns	23
Embroidery Pattern Color Change Table	24
Embroidery Patterns	24
Utility embroidery patterns / Large buttonhole patterns	41
Monograms	46
Decorative Alphabet Patterns	48
Examples of Combinations	87
Font Name Chart	95

Inhalt

Übersicht der Stickmuster	3
Bildschirm für die Musterauswahl	3
Stickmuster	3
Umrandung	5
Nutzstich-Stickmuster/Muster für große Knopflöcher	6
Monogramme	7
Buchstabenmuster	8
Dekor-Buchstabenmuster	19
Quiltrandmuster	23
Stickdesign-Farbtabelle	24
Stickmuster	24
Nutzstich-Stickmuster/Muster für große Knopflöcher	41
Monogramme	46
Dekor-Buchstabenmuster	48
Kombinationsbeispiele	87
Tabelle der Schriftarten	95

Table des matières

Sommaire des motifs de broderie	3
Écran de sélection des types de motifs	3
Motifs de broderie	3
Motifs d'encadrement	5
Motifs de broderie courants/Grands motifs de boutonniers	6
Monogrammes	7
Motifs de caractères	8
Motifs d'alphabet décoratif	19
Motifs de bordure en points quilting (courtepointe)	23
Tableau de changement des couleurs des motifs de broderie	24
Motifs de broderie	24
Motifs de broderie courants/Grands motifs de boutonniers	41
Monogrammes	46
Motifs d'alphabet décoratif	48
Exemples de combinaisons	87
Tableau des noms de polices	95

Inhoudsopgave

Overzicht van borduurpatronen	3
Patroontypekeuzescherf	3
Borduurpatronen	3
Kader- en omrandingspatronen	5
Borduursteken/Grote knoopsgatpatronen	6
Monogrammen	7
Lettertypen	8
Decoratieve sierlettertypen	19
Quilt randpatronen	23
Kleurenvolgorde voor de borduurpatronen	24
Borduurpatronen	24
Borduursteken/Grote knoopsgatpatronen	41
Monogrammen	46
Decoratieve sierlettertypen	48
Voorbeelden van combinaties	87
Overzicht lettertypen	95

Sommario

Riepilogo dei ricami	3
Schermata di selezione del tipo di ricamo	3
Schema colori dei ricami	3
Ricami di cornici	5
Ricami utili/Ricami per asole grandi	6
Monogrammi	7
Ricami con caratteri	8
Ricami Alfabeto decorativo	19
Ricami per bordi per trapuntatura	23
Tabella dei cambi colore dei ricami	24
Schema colori dei ricami	24
Ricami utili/Ricami per asole grandi	41
Monogrammi	46
Ricami Alfabeto decorativo	48
Esempi di combinazioni	87
Tabella nomi dei font	95

Contenido

Resumen de diseños de bordado	3
Pantalla de selección del tipo de patrón	3
Patrones de bordado	3
Costura de encuadre	5
Patrones de bordado de utilidad/Patrones para ojales de gran tamaño	6
Monogramas	7
Patrones de caracteres	8
Patrones de alfabeto decorativo	19
Patrones de borde de acolchado	23
Tabla de cambio de color para patrones de bordado	24
Patrones de bordado	24
Patrones de bordado de utilidad/Patrones para ojales de gran tamaño	41
Monogramas	46
Patrones de alfabeto decorativo	48
Ejemplos de combinaciones	87
Diagrama de nombre de las fuentes	95

Índice

Resumo de padrões de bordado	3
Tela de seleção do tipo de padrão	3
Padrões de bordado	3
Desenhos de molduras	5
Padrões de bordado úteis/Padrões de casas para botões grandes	6
Monogramas	7
Padrões de caracteres	8
Padrões de alfabeto decorativo	19
Padrões de arremate de acolchoados	23
Tabela de alteração de cor de padrões de bordado	24
Padrões de bordado	24
Padrões de bordado úteis/Padrões de casas para botões grandes	41
Monogramas	46
Padrões de alfabeto decorativo	48
Exemplos de combinações	87
Quadro de nomes de fontes	95

Содержание

Обзор дизайнов для вышивания	3
Экран выбора типа дизайнов	3
Дизайны для вышивания	3
Дизайны "Рамки"	5
Основные строчки для вышивания/Большие петли для вышивания	6
Монограммы	7
Шрифты	8
Декоративные шрифты	19
Дизайны бордюрной вышивки для квилтинга	23
Таблицы цветов нитей для вышивок	24
Дизайны для вышивания	24
Основные строчки для вышивания/Большие петли для вышивания	41
Монограммы	46
Декоративные шрифты	48
Примеры использования	87
Таблица названий шрифтов	95

Summary of Embroidery Patterns Übersicht der Stickmuster Sommaire des motifs de broderie Overzicht van borduurpatronen Riepilogo dei ricami Resumen de diseños de bordado Resumo de padrões de bordado Обзор дизайнов для вышивания

- ◆ Pattern type selection screen
- ◆ Écran de sélection des types de motifs
- ◆ Schermata di selezione del tipo di ricamo
- ◆ Tela de seleção do tipo de padrão

- ◆ Bildschirm für die Musterauswahl
- ◆ Patroontypekeuzescherf
- ◆ Pantalla de selección del tipo de patrón
- ◆ Экран выбора типа дизайнов



- ◆ Embroidery Patterns
- ◆ Motifs de broderie
- ◆ Schema colori dei ricami
- ◆ Padrões de bordado

- ◆ Stickmuster
- ◆ Borduurpatronen
- ◆ Patrones de bordado
- ◆ Дизайны для вышивания

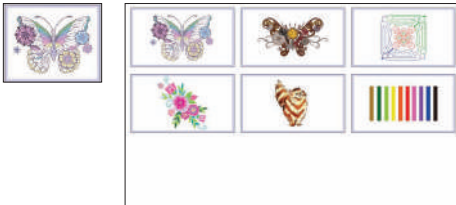

- "Featured" Designs
- Motifs « à la Une »
- Ricami "inclusi"
- Desenhos "em destaque"

- „Vorgestellte“ Stickmuster
- Specifieke ontwerpen
- Diseños "Destacados"
- Дизайны "Тематические"



- "Steam Punk" Designs
- Motifs « steampunk »
- Ricami "steampunk"
- Desenhos "Steam Punk"



- „Steampunk“-Stickmuster
- Steampunk ontwerpen
- Diseños "Steam Punk"
- Дизайны "Стимпанк"



- "Quilt" Designs
- Motifs pour quilting (courtepointe)
- Ricami "per quilting"
- Desenhos "para acolchoados"



- „Quilt“-Stickmuster
- Quilt ontwerpen
- Diseños "Acolchado"
- Дизайны "Квилт"



- "Craft" Designs
- Motifs "artisansaux"
- Ricami "creativi"
- Desenhos "artesanais"



- „Craft“-Stickmuster
- Craft- en hobbyborduurpatronen
- Diseños "Artesanales"
- Дизайны "Декор"



- "Variety" Designs
- Motifs divers
- Ricami "originali"
- Desenhos "diversos"



- „Variety“-Stickmuster
- Diverse thema borduurpatronen
- Diseños de temas diversos
- Дизайны "Разные"

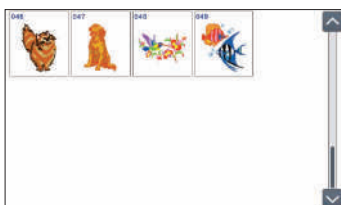

- Common Design Patterns
- Motifs courants
- Ricami di uso comune
- Padrões comuns de desenhos

- Allgemeine Stickdesigns
- Test- en oefenborduurpatronen
- Diseños comunes
- Стандартные дизайны

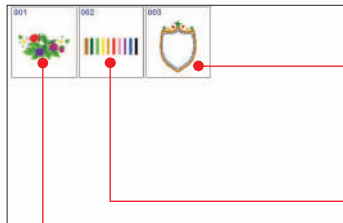

For tutorial practice
 Für Lernübungen
 Pour une pratique d'apprentissage
 Als oefening
 Da utilizzare per il tutorial
 Para práctica tutorial
 Para a prática tutorial
 Для практического обучения

For tutorial practice of embroidering appliqué
 Für Lernprogramm-Übungen von Stickapplikationen
 Pour une pratique d'apprentissage de broderie d'un motif d'appliqué
 Voor het oefenen van applicaties aan de hand van de lesguids
 Per la pratica guidata del ricamo dell'appliqué
 Para la práctica del tutorial de bordado de adornos
 Para a prática tutorial de apliques de bordado
 В целях обучения вышиванию аппликаций

For checking the thread tension
 Zur Überprüfung der Fadenspannung
 Pour contrôler la tension du fil
 Om de draadspanning te controleren
 Per controllare la tensione del filo
 Para comprobar la tensión del hilo
 Para verificar a tensão da linha
 Для проверки натяжения нити

- ◆ Frame Patterns
- ◆ Motifs d'encadrement
- ◆ Ricami di cornici
- ◆ Desenhos de molduras

- ◆ Umrandung
- ◆ Kader- en omrandingspatronen
- ◆ Costura de encuadre
- ◆ Дизайны "Рамки"

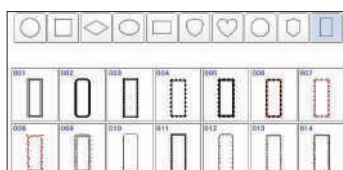
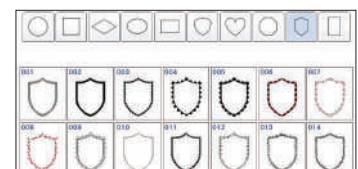
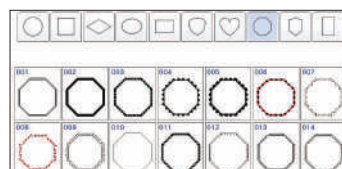
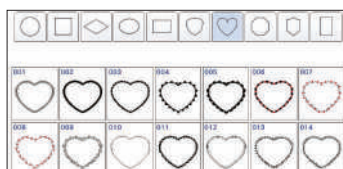
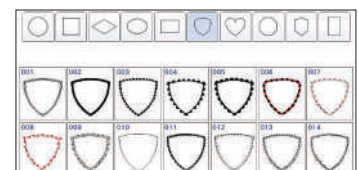
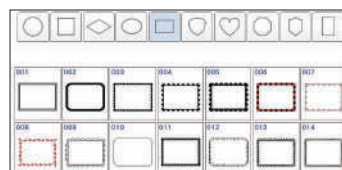
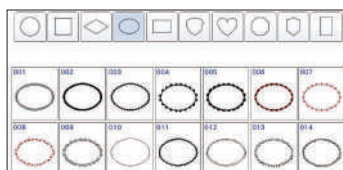
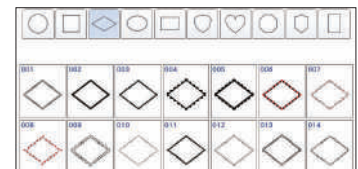
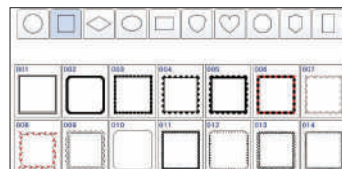
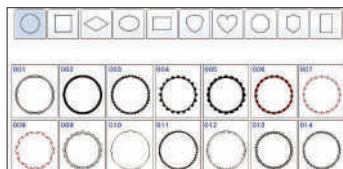

- ◆ Utility embroidery patterns / Large buttonhole patterns
- ◆ Motifs de broderie courants/ Grands motifs de boutonnières
- ◆ Ricami utili/Ricami per asole grandi
- ◆ Padrões de bordado úteis/ Padrões de casas para botões grandes

- ◆ Nutzstich-Stickmuster/ Muster für große Knopflöcher
- ◆ Borduursteken/ Grote knoopsgatpatronen
- ◆ Patrones de bordado de utilidad/ Patrones para ojales de gran tamaño
- ◆ Основные строчки для вышивания/ Большие петли для вышивания

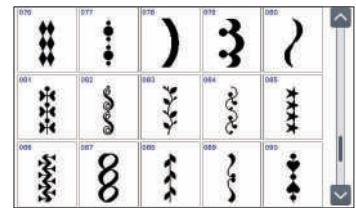
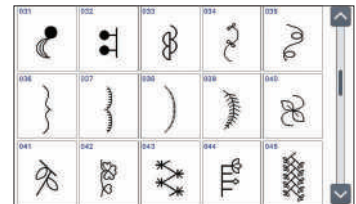
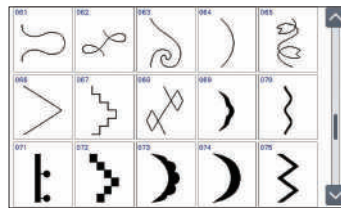
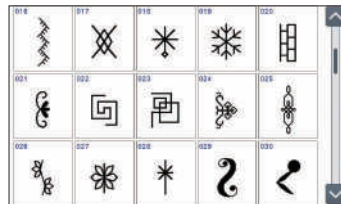
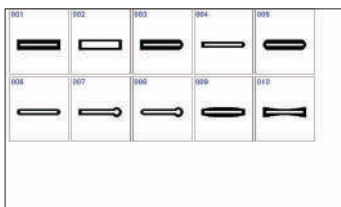
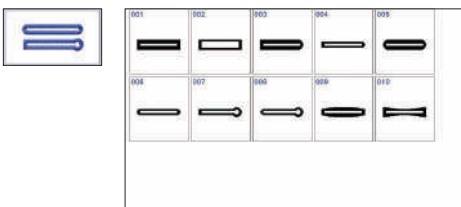
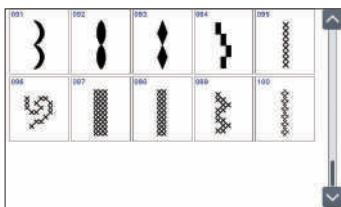
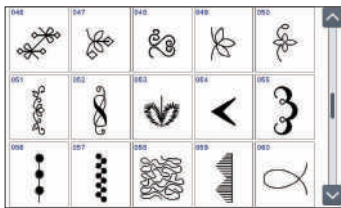
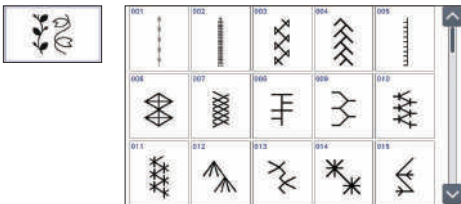

- ◆ Monograms
- ◆ Monogrammes
- ◆ Monogrammi
- ◆ Monogramas

- ◆ Monogramme
- ◆ Monogrammen
- ◆ Monogramas
- ◆ Монограммы

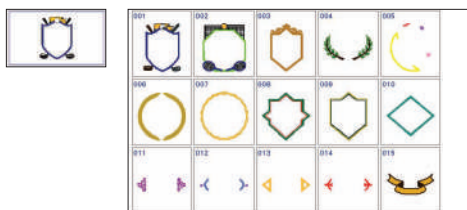
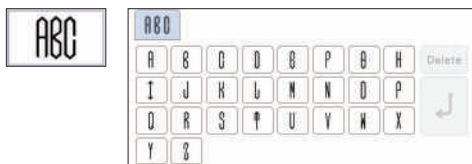
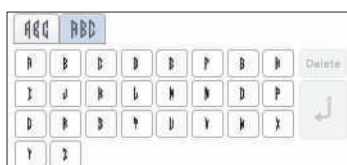
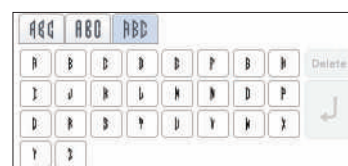
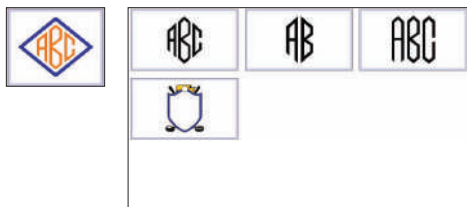

- *Monogram frames
- *Encadrements pour monogrammes
- *Cornici per monogrammi
- *Molduras de monograma

- *Monogramrahmen
- *Monogramkaders en omrandingen
- *Costuras de encuadre con texto de monograma
- *Рамки для монограмм

03
ABC

ABC	abc	0-9..	&?!	ÁÁá	NÑn	Delete	
A	B	C	D	E	F	G	H
I	J	K	L	M	N	O	P
Q	R	S	T	U	V	W	X
Y	Z						

ABC	abc	0-9..	&?!	ÁÁá	NÑn	Delete	
&	?	!	@	<	>	()
[]	/	\	~	:	:	©
®	™	"	"	"	'	'	'

ABC	abc	0-9..	&?!	ÁÁá	NÑn	Delete	
a	b	c	d	e	f	g	h
i	j	k	l	m	n	o	p
q	r	s	t	u	v	w	x
y	z						

ABC	abc	0-9..	&?!	ÁÁá	NÑn	Delete	
À	Ä	Å	Æ	à	á	â	ã
ä	å	æ	Ç	ç	Ð	È	É
Ê	Ë	è	é	ê	ë	Ï	Ì
Í	Î	Ì	Í	Î	Ï	Ì	Í

ABC	abc	0-9..	&?!	ÁÁá	NÑn	Delete	
0	1	2	3	4	5	6	7
8	9	#	%	\$	£	€	¥
-	+	x	÷	=	*	.	,

ABC	abc	0-9..	&?!	ÁÁá	NÑn	Delete	
Ñ	Ñ	ñ	Ö	Ö	ø	Õ	œ
ò	ó	ô	õ	ø	œ	ř	
Ş	ş	ŕ	Û	Û	ù	ú	û
ü	ı	Ɔ	Ɔ	Ɔ			

04
ABC

ABC	abc	0-9..	&?!	ÁÁá	NÑn	Delete	
A	B	C	D	E	F	G	H
I	J	K	L	M	N	O	P
Q	R	S	T	U	V	W	X
Y	Z						

ABC	abc	0-9..	&?!	ÁÁá	NÑn	Delete	
&	?	!	@	<	>	()
[]	/	\	~	:	:	©
®	™	"	"	"	'	'	'

ABC	abc	0-9..	&?!	ÁÁá	NÑn	Delete	
a	b	c	d	e	f	g	h
i	j	k	l	m	n	o	p
q	r	s	t	u	v	w	x
y	z						

ABC	abc	0-9..	&?!	ÁÁá	NÑn	Delete	
À	Ä	Å	Æ	à	á	â	ã
ä	å	æ	Ç	ç	Ð	È	É
Ê	Ë	è	é	ê	ë	Ï	Ì
Í	Î	Ì	Í	Î	Ï	Ì	Í

ABC	abc	0-9..	&?!	ÁÁá	NÑn	Delete	
0	1	2	3	4	5	6	7
8	9	#	%	\$	£	€	¥
-	+	x	÷	=	*	.	,

ABC	abc	0-9..	&?!	ÁÁá	NÑn	Delete	
Ñ	Ñ	ñ	Ö	Ö	ø	Õ	œ
ò	ó	ô	õ	ø	œ	ř	
Ť	Û	Û	ù	ú	ú	ú	z
Ɔ	Ɔ	Ɔ					

05
ABC

ABC	abc	0-9..	&?!	ÁÁá	NÑn	Delete	
A	B	C	D	E	F	G	H
I	J	K	L	M	N	O	P
Q	R	S	T	U	V	W	X
Y	Z						

ABC	abc	0-9..	&?!	ÁÁá	NÑn	Delete	
&	?	!	@	()	/	'

ABC	abc	0-9..	&?!	ÁÁá	NÑn	Delete	
a	b	c	d	e	f	g	h
i	j	k	l	m	n	o	p
q	r	s	t	u	v	w	x
y	z						

ABC	abc	0-9..	&?!	ÁÁá	NÑn	Delete	
À	Ä	Å	Æ	à	á	â	ã
ä	å	æ	Ç	ç	è	é	ê
ë	ì						

ABC	abc	0-9..	&?!	ÁÁá	NÑn	Delete	
0	1	2	3	4	5	6	7
8	9	-	.	,			

ABC	abc	0-9..	&?!	ÁÁá	NÑn	Delete	
Ñ	ñ	Ö	ø	ò	ó	œ	Û
ù	ü	Ɔ					

06
ABC

ABC	abc	0-9..	&?!	ÁÁá	NÑn	Delete	
A	B	C	D	E	F	G	H
I	J	K	L	M	N	O	P
Q	R	S	T	U	V	W	X
Y	Z						

ABC	abc	0-9..	&?!	ÁÁá	NÑn	Delete	
&	?	!	@	<	>	[]
[]	/	\	~	:	:	©
©	™	®	®	®	®	®	®

ABC	abc	0-9..	&?!	ÁÁá	NÑn	Delete	
a	b	c	d	e	f	g	h
i	j	k	l	m	n	o	p
q	r	s	t	u	v	w	x
y	z						

ABC	abc	0-9..	&?!	ÁÁá	NÑn	Delete	
À	Ä	Å	Æ	à	á	â	ã
ä	å	æ	Ç	ç	Ð	È	É
Ê	Ë	è	é	ê	ë	Ï	Ì
Í	Î	Ì	Í	Î	Ï	Ì	Í

ABC	abc	0-9..	&?!	ÁÁá	NÑn	Delete	
0	1	2	3	4	5	6	7
8	9	#	%	\$	£	€	¥
-	+	x	÷	=	*	.	,

ABC	abc	0-9..	&?!	ÁÁá	NÑn	Delete	
Ñ	Ñ	ñ	Ö	Ö	ø	Õ	œ
ò	ó	ô	õ	ø	œ	ř	
Ş	ş	ŕ	Û	Û	ù	ú	û
ü	ı	Ɔ	Ɔ	Ɔ			

07
ABC

ABC	abc	0-9..	&?!	ÁÁá	NÑn	Delete	
A	B	C	D	E	F	G	H
I	J	K	L	M	N	O	P
Q	R	S	T	U	V	W	X
Y	Z						

ABC	abc	0-9..	&?!	ÁÁá	NÑn	Delete	
a	b	c	d	e	f	g	h
i	j	k	l	m	n	o	p
q	r	s	t	u	v	w	x
y	z						

ABC	abc	0-9..	&?!	ÁÁá	NÑn	Delete	
0	1	2	3	4	5	6	7
8	9	#	%	\$	£	€	¥
-	+	x	÷	=	*	.	,

ABC	abc	0-9..	&?!	ÁÀá	NÑn			
&	?	!	@	<	>	()	Delete
l	l	/	\	~	:	:	©	↓
®	™	"	"	"	'	'	'	↵

ABC	abc	0-9..	&?!	ÁÀá	NÑn			
À	Ã	Ä	Æ	à	á	â	ä	Delete
ä	å	æ	ç	ç	ð	è	é	↓
ê	ë	è	é	è	ë	ğ	ğ	↵
í	ï	ì	í	ì	ï	ı	ı	-

ABC	abc	0-9..	&?!	ÁÀá	NÑn			
Ñ	Ñ	ñ	Ò	Ò	ø	Ó	œ	Delete
ò	ó	ô	õ	ö	ø	æ	ř	↓
š	š	ř	Ú	Ú	ú	ú	ú	↵
ü	z	Ɔ	Ɔ	Ɔ	↵			

08
ABC

ABC	abc	0-9..	&?!	ÁÀá	NÑn			
A	B	C	D	E	F	G	H	Delete
I	J	K	L	M	N	O	P	↓
Q	R	S	T	U	V	W	X	↵
Y	Z							

ABC	abc	0-9..	&?!	ÁÀá	NÑn			
a	b	c	d	e	f	g	h	Delete
i	j	k	l	m	n	o	p	↓
q	r	s	t	u	v	w	x	↵
y	z							

ABC	abc	0-9..	&?!	ÁÀá	NÑn			
0	1	2	3	4	5	6	7	Delete
8	9	#	%	\$	£	€	¥	↓
-	+	x	÷	=	*	.	,	↵

ABC	abc	0-9..	&?!	ÁÀá	NÑn			
&	?	!	@	<	>	()	Delete
l	l	/	\	~	:	:	©	↓
®	™	"	"	"	'	'	'	↵

ABC	abc	0-9..	&?!	ÁÀá	NÑn			
À	Ã	Ä	Æ	à	á	â	ä	Delete
ä	å	æ	ç	ç	ð	è	é	↓
ê	ë	è	é	è	ë	ğ	ğ	↵
í	ï	ì	í	ì	ï	ı	ı	-

ABC	abc	0-9..	&?!	ÁÀá	NÑn			
Ñ	Ñ	ñ	Ò	Ò	ø	Ó	œ	Delete
ò	ó	ô	õ	ö	ø	æ	ř	↓
š	š	ř	Ú	Ú	ú	ú	ú	↵
ü	z	Ɔ	Ɔ	Ɔ	↵			

09
ABC

ABC	abc	0-9..	&?!	ÁÀá	NÑn			
A	B	C	D	E	F	G	H	Delete
I	J	K	L	M	N	O	P	↓
Q	R	S	T	U	V	W	X	↵
Y	Z							

ABC	abc	0-9..	&?!	ÁÀá	NÑn			
a	b	c	d	e	f	g	h	Delete
i	j	k	l	m	n	o	p	↓
q	r	s	t	u	v	w	x	↵
y	z							

ABC	abc	0-9..	&?!	ÁÀá	NÑn			
0	1	2	3	4	5	6	7	Delete
8	9	-	.	,				↓

ABC	abc	0-9..	&?!	ÁÀá	NÑn			
&	?	!	@	()	/	'	Delete

ABC	abc	0-9..	&?!	ÁÀá	NÑn			
À	Ã	Ä	Æ	à	á	â	ä	Delete
ä	å	æ	ç	ç	ð	è	é	↓
ê	ë	è	é	è	ë	ğ	ğ	↵
í	ï	ì	í	ì	ï	ı	ı	-

ABC	abc	0-9..	&?!	ÁÀá	NÑn			
Ñ	Ñ	ñ	Ò	Ò	ø	Ó	œ	Delete
ò	ó	ô	õ	ö	ø	æ	ř	↓
š	š	ř	Ú	Ú	ú	ú	ú	↵
ü	z	Ɔ	Ɔ	Ɔ	↵			

10
ABC

ABC	abc	0-9..	&?!	ÁÀá	NÑn			
A	B	C	D	E	F	G	H	Delete
I	J	K	L	M	N	O	P	↓
Q	R	S	T	U	V	W	X	↵
Y	Z							

ABC	abc	0-9..	&?!	ÁÀá	NÑn			
a	b	c	d	e	f	g	h	Delete
i	j	k	l	m	n	o	p	↓
q	r	s	t	u	v	w	x	↵
y	z							

ABC	abc	0-9..	&?!	ÁÀá	NÑn			
0	1	2	3	4	5	6	7	Delete
8	9	#	%	\$	£	€	¥	↓
-	+	x	÷	=	*	.	,	↵

ABC	abc	0-9..	&?!	ÁÀá	NÑn			
&	?	!	@	<	>	()	Delete
l	l	/	\	~	:	:	©	↓
®	™	"	"	"	'	'	'	↵

ABC	abc	0-9..	&?!	ÁÀá	NÑn			
À	Ã	Ä	Æ	à	á	â	ä	Delete
ä	å	æ	ç	ç	ð	è	é	↓
ê	ë	è	é	è	ë	ğ	ğ	↵
í	ï	ì	í	ì	ï	ı	ı	-

ABC	abc	0-9..	&?!	ÁÀá	NÑn			
Ñ	Ñ	ñ	Ò	Ò	ø	Ó	œ	Delete
ò	ó	ô	õ	ö	ø	æ	ř	↓
š	š	ř	Ú	Ú	ú	ú	ú	↵
ü	z	Ɔ	Ɔ	Ɔ	↵			

11
ABC

ABC	abc	0-9..	&?!	ÁÀá	NÑn			
A	B	C	D	E	F	G	H	Delete
I	J	K	L	M	N	O	P	↓
Q	R	S	T	U	V	W	X	↵
Y	Z							

ABC	abc	0-9..	&?!	ÁÀá	NÑn			
a	b	c	d	e	f	g	h	Delete
i	j	k	l	m	n	o	p	↓
q	r	s	t	u	v	w	x	↵
y	z							

ABC	abc	0-9..	&?!	ÁÀá	NÑn			
0	1	2	3	4	5	6	7	Delete
8	9	#	%	\$	£	€	¥	↓
-	+	x	÷	=	*	.	,	↵

ABC	abc	0-9..	&?!	ÁÀá	NÑn			
&	?	!	@	<	>	()	Delete
l	l	/	\	~	:	:	©	↓
®	™	"	"	"	'	'	'	↵

ABC	abc	0-9..	&?!	ÁÀá	NÑn			
À	Ã	Ä	Æ	à	á	â	ä	Delete
ä	å	æ	ç	ç	ð	è	é	↓
ê	ë	è	é	è	ë	ğ	ğ	↵
í	ï	ì	í	ì	ï	ı	ı	-

ABC	abc	0-9..	&?!	ÁÀá	NÑn			
Ñ	Ñ	ñ	Ò	Ò	ø	Ó	œ	Delete
ò	ó	ô	õ	ö	ø	æ	ř	↓
š	š	ř	Ú	Ú	ú	ú	ú	↵
ü	z	Ɔ	Ɔ	Ɔ	↵			

12
 ABC

ABC	abc	0-9..	&?!	ÄÄä	NNn	Delete	
A	B	C	D	E	F	G	H
I	J	K	L	M	N	O	P
Q	R	S	T	U	V	W	X
Y	Z						

ABC	abc	0-9..	&?!	ÄÄä	NNn	Delete	
&	?	!	@	<	>	()
[]	/	\	~	:	:	©
®	™	"	"	"	'	'	'

ABC	abc	0-9..	&?!	ÄÄä	NNn	Delete	
a	b	c	d	e	f	g	h
i	j	k	l	m	n	o	p
q	r	s	t	u	v	w	x
y	z						

ABC	abc	0-9..	&?!	ÄÄä	NNn	Delete	
À	Á	Â	Ã	Ä	Å	À	Á
Â	Ã	Ä	Å	Ç	Ç	Ð	É
É	Ê	Ë	Ê	Ë	Ë	Ë	Ë
Ì	Í	Î	Ï	Î	Ï	Ï	Ï

ABC	abc	0-9..	&?!	ÄÄä	NNn	Delete	
0	1	2	3	4	5	6	7
8	9	#	%	\$	£	€	¥
-	+	x	÷	=	*	.	,

ABC	abc	0-9..	&?!	ÄÄä	NNn	Delete	
Ñ	Ñ	ñ	Ò	Ò	ó	Ô	Õ
ò	ó	ô	õ	ø	œ	ƒ	
§	§	†	Ù	Ú	Û	Ü	Ù
ü	z	Þ	þ	ß			

13
 ABC

ABC	abc	0-9..	&?!	ÄÄä	NNn	Delete	
A	B	C	D	E	F	G	H
I	J	K	L	M	N	O	P
Q	R	S	T	U	V	W	X
Y	Z						

ABC	abc	0-9..	&?!	ÄÄä	NNn	Delete	
&	?	!	@	<	>	()
[]	/	\	~	:	:	©
®	™	"	"	"	'	'	'

ABC	abc	0-9..	&?!	ÄÄä	NNn	Delete	
a	b	c	d	e	f	g	h
i	j	k	l	m	n	o	p
q	r	s	t	u	v	w	x
y	z						

ABC	abc	0-9..	&?!	ÄÄä	NNn	Delete	
À	Á	Â	Ã	Ä	Å	À	Á
Â	Ã	Ä	Å	Ç	Ç	Ð	É
É	Ê	Ë	Ê	Ë	Ë	Ë	Ë
Ì	Í	Î	Ï	Î	Ï	Ï	Ï

ABC	abc	0-9..	&?!	ÄÄä	NNn	Delete	
0	1	2	3	4	5	6	7
8	9	#	%	\$	£	€	¥
-	+	x	÷	=	*	.	,

ABC	abc	0-9..	&?!	ÄÄä	NNn	Delete	
Ñ	Ñ	ñ	Ò	Ò	ó	Ô	Õ
ò	ó	ô	õ	ø	œ	ƒ	
§	§	†	Ù	Ú	Û	Ü	Ù
ü	z	Þ	þ	ß			

14
 ABC

ABC	abc	0-9..	&?!	ÄÄä	NNn	Delete	
A	B	C	D	E	F	G	H
I	J	K	L	M	N	O	P
Q	R	S	T	U	V	W	X
Y	Z						

ABC	abc	0-9..	&?!	ÄÄä	NNn	Delete	
&	?	!	@	<	>	()
[]	/	\	~	:	:	©
®	™	"	"	"	'	'	'

ABC	abc	0-9..	&?!	ÄÄä	NNn	Delete	
a	b	c	d	e	f	g	h
i	j	k	l	m	n	o	p
q	r	s	t	u	v	w	x
y	z						

ABC	abc	0-9..	&?!	ÄÄä	NNn	Delete	
À	Á	Â	Ã	Ä	Å	À	Á
Â	Ã	Ä	Å	Ç	Ç	Ð	É
É	Ê	Ë	Ê	Ë	Ë	Ë	Ë
Ì	Í	Î	Ï	Î	Ï	Ï	Ï

ABC	abc	0-9..	&?!	ÄÄä	NNn	Delete	
0	1	2	3	4	5	6	7
8	9	#	%	\$	£	€	¥
-	+	x	÷	=	*	.	,

ABC	abc	0-9..	&?!	ÄÄä	NNn	Delete	
Ñ	Ñ	ñ	Ò	Ò	ó	Ô	Õ
ò	ó	ô	õ	ø	œ	ƒ	
§	§	†	Ù	Ú	Û	Ü	Ù
ü	z	Þ	þ	ß			

15
 ABC

ABC	abc	0-9..	&?!	ÄÄä	NNn	Delete	
A	B	C	D	E	F	G	H
I	J	K	L	M	N	O	P
Q	R	S	T	U	V	W	X
Y	Z						

ABC	abc	0-9..	&?!	ÄÄä	NNn	Delete	
&	?	!	@	<	>	()
[]	/	\	~	:	:	©
®	™	"	"	"	'	'	'

ABC	abc	0-9..	&?!	ÄÄä	NNn	Delete	
a	b	c	d	e	f	g	h
i	j	k	l	m	n	o	p
q	r	s	t	u	v	w	x
y	z						

ABC	abc	0-9..	&?!	ÄÄä	NNn	Delete	
À	Á	Â	Ã	Ä	Å	À	Á
Â	Ã	Ä	Å	Ç	Ç	Ð	É
É	Ê	Ë	Ê	Ë	Ë	Ë	Ë
Ì	Í	Î	Ï	Î	Ï	Ï	Ï

ABC	abc	0-9..	&?!	ÄÄä	NNn	Delete	
0	1	2	3	4	5	6	7
8	9	#	%	\$	£	€	¥
-	+	x	÷	=	*	.	,

ABC	abc	0-9..	&?!	ÄÄä	NNn	Delete	
Ñ	Ñ	ñ	Ò	Ò	ó	Ô	Õ
ò	ó	ô	õ	ø	œ	ƒ	
§	§	†	Ù	Ú	Û	Ü	Ù
ü	z	Þ	þ	ß			

16
 ABC

ABC	abc	0-9..	&?!	ÄÄä	NNn	Delete	
A	B	C	D	E	F	G	H
I	J	K	L	M	N	O	P
Q	R	S	T	U	V	W	X
Y	Z						

ABC	abc	0-9..	&?!	ÄÄä	NNn	Delete	
&	?	!	@	<	>	()
[]	/	\	~	:	:	©
®	™	"	"	"	'	'	'

ABC	abc	0-9..	&?!	ÄÄä	NNn	Delete	
a	b	c	d	e	f	g	h
i	j	k	l	m	n	o	p
q	r	s	t	u	v	w	x
y	z						

ABC	abc	0-9..	&?!	ÄÄä	NNn	Delete	
À	Á	Â	Ã	Ä	Å	À	Á
Â	Ã	Ä	Å	Ç	Ç	Ð	É
É	Ê	Ë	Ê	Ë	Ë	Ë	Ë
Ì	Í	Î	Ï	Î	Ï	Ï	Ï

ABC	abc	0-9..	&?!	ÄÄä	NNn	Delete	
0	1	2	3	4	5	6	7
8	9	#	%	\$	£	€	¥
-	+	x	÷	=	*	.	,

ABC	abc	0-9..	&?!	ÄÄä	NNn	Delete	
Ñ	Ñ	ñ	Ò	Ò	ó	Ô	Õ
ò	ó	ô	õ	ø	œ	ƒ	
§	§	†	Ù	Ú	Û	Ü	Ù
ü	z	Þ	þ	ß			

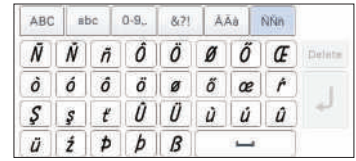
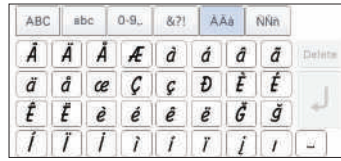

17
ABC

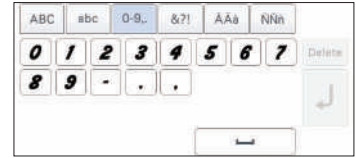
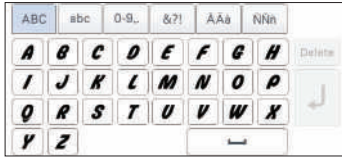

18
ABC

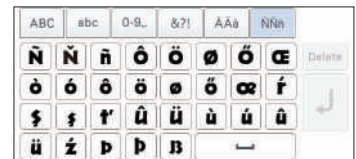
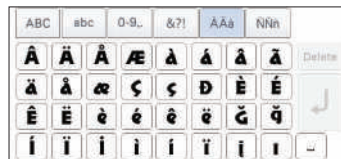
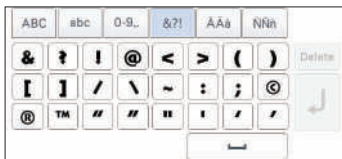

19
ABC

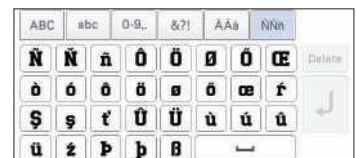

20
ABC

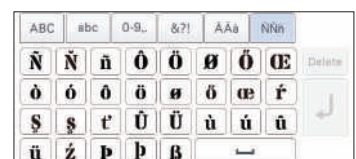
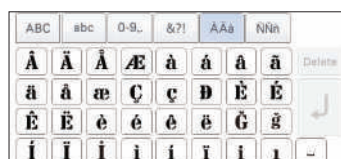
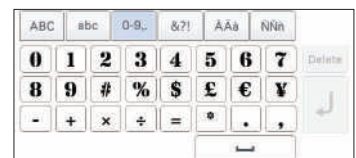
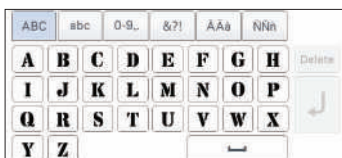

21
ABC

ABC	abc	0-9..	&?!	ÁÁá	NÑn	Delete	
A	B	G	D	E	F	G	H
I	J	K	L	M	N	O	P
Q	R	S	T	U	V	W	X
Y	Z						

ABC	abc	0-9..	&?!	ÁÁá	NÑn	Delete	
a	b	c	d	e	f	g	h
i	j	k	l	m	n	o	p
q	r	s	t	u	v	w	x
y	z						

ABC	abc	0-9..	&?!	ÁÁá	NÑn	Delete	
0	1	2	3	4	5	6	7
8	9	#	%	\$	€	¥	Delete
-	+	x	÷	=	*	.	,

ABC	abc	0-9..	&?!	ÁÁá	NÑn	Delete	
&	?	!	@	<	>	()
		/	\	~	:	:	©
®	™	“	”	”	'	'	'

ABC	abc	0-9..	&?!	ÁÁá	NÑn	Delete	
Á	Ă	Ȃ	Æ	à	á	â	ã
ä	å	æ	Ç	ç	Ð	È	É
Ê	Ë	è	é	ê	ë	Ğ	ğ
Í	İ	ı	ı	ı	ı	ı	ı

ABC	abc	0-9..	&?!	ÁÁá	NÑn	Delete	
Ñ	Ń	ñ	Ŏ	Ō	Œ	Œ	Œ
ò	ó	ô	õ	ø	ö	œ	ƒ
Š	š	ţ	Ů	Ů	ù	ú	û
ü	ž	Ɔ	Ɔ	Ɔ	Delete		

22
ABC

ABC	abc	0-9..	&?!	ÁÁá	NÑn	Delete	
A	B	C	D	E	F	G	H
I	J	K	L	M	N	O	P
Q	R	S	T	U	V	W	X
Y	Z						

ABC	abc	0-9..	&?!	ÁÁá	NÑn	Delete	
a	b	c	d	e	f	g	h
i	j	k	l	m	n	o	p
q	r	s	t	u	v	w	x
y	z						

ABC	abc	0-9..	&?!	ÁÁá	NÑn	Delete	
0	1	2	3	4	5	6	7
8	9	#	%	\$	£	€	¥
-	+	x	÷	=	*	.	,

ABC	abc	0-9..	&?!	ÁÁá	NÑn	Delete	
&	?	!	@	<	>	()
		/	\	~	:	:	©
®	™	“	”	”	'	'	'

ABC	abc	0-9..	&?!	ÁÁá	NÑn	Delete	
Á	Ă	Ȃ	Æ	à	á	â	ã
ä	å	æ	Ç	ç	Ð	È	É
Ê	Ë	è	é	ê	ë	Ğ	ğ
Í	İ	ı	ı	ı	ı	ı	ı

ABC	abc	0-9..	&?!	ÁÁá	NÑn	Delete	
Ñ	Ń	ñ	Ŏ	Ō	Œ	Œ	Œ
ò	ó	ô	õ	ø	ö	œ	ƒ
Š	š	ţ	Ů	Ů	ù	ú	û
ü	ž	Ɔ	Ɔ	Ɔ	Delete		

23
ABC

ABC	abc	0-9..	&?!			Delete	
A	B	C	D	E	F	G	H
I	J	K	L	M	N	O	P
Q	R	S	T	U	V	W	X
Y	Z						

ABC	abc	0-9..	&?!			Delete	
a	b	c	d	e	f	g	h
i	j	k	l	m	n	o	p
q	r	s	t	u	v	w	x
y	z						

ABC	abc	0-9..	&?!			Delete	
0	1	2	3	4	5	6	7
8	9	-	=	.	,	Delete	

ABC	abc	0-9..	&?!			Delete	
&	?	!	<	>	[]	/
\	~	:	:	“	”	'	'

24
ABC

ABC	abc	0-9..	&?!	ÁÁá	NÑn	Delete	
A	B	C	D	E	F	G	H
I	J	K	L	M	N	O	P
Q	R	S	T	U	V	W	X
Y	Z						

ABC	abc	0-9..	&?!	ÁÁá	NÑn	Delete	
a	b	c	d	e	f	g	h
i	j	k	l	m	n	o	p
q	r	s	t	u	v	w	x
y	z						

ABC	abc	0-9..	&?!	ÁÁá	NÑn	Delete	
0	1	2	3	4	5	6	7
8	9	#	%	\$	£	€	¥
-	+	x	÷	=	*	.	,

ABC	abc	0-9..	&?!	ÁÁá	NÑn	Delete	
&	?	!	@	<	>	()
		/	\	~	:	:	©
®	™	“	”	”	'	'	'

ABC	abc	0-9..	&?!	ÁÁá	NÑn	Delete	
Á	Ă	Ȃ	Æ	à	á	â	ã
ä	å	æ	Ç	ç	Ð	È	É
Ê	Ë	è	é	ê	ë	Ğ	ğ
Í	İ	ı	ı	ı	ı	ı	ı

ABC	abc	0-9..	&?!	ÁÁá	NÑn	Delete	
Ñ	Ń	ñ	Ŏ	Ō	Œ	Œ	Œ
ò	ó	ô	õ	ø	ö	œ	ƒ
Š	š	ţ	Ů	Ů	ù	ú	û
ü	ž	Ɔ	Ɔ	Ɔ	Delete		

25
ABC

ABC	abc	0-9..	&?!	ÁÁá	NÑn	Delete	
A	B	C	D	E	F	G	H
I	J	K	L	M	N	O	P
Q	R	S	T	U	V	W	X
Y	Z						

ABC	abc	0-9..	&?!	ÁÁá	NÑn	Delete	
a	b	c	d	e	f	g	h
i	j	k	l	m	n	o	p
q	r	s	t	u	v	w	x
y	z						

ABC	abc	0-9..	&?!	ÁÁá	NÑn	Delete	
0	1	2	3	4	5	6	7
8	9	#	%	\$	£	€	¥
-	+	x	÷	=	*	.	,

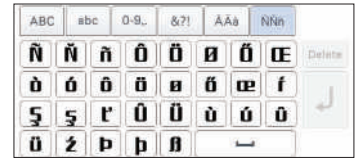

26 АБВ

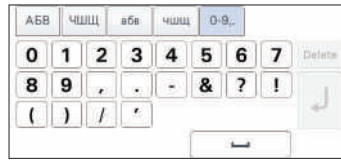
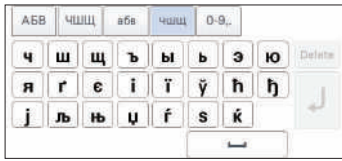
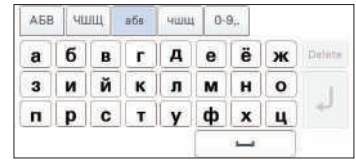
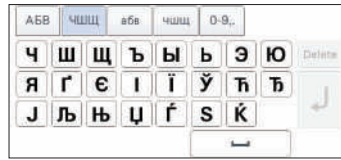
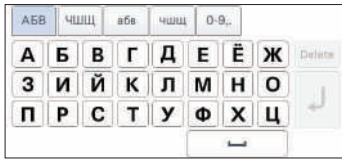

27 АБВ

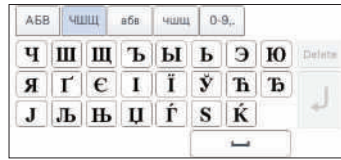

28 ABCDE

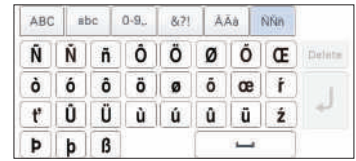
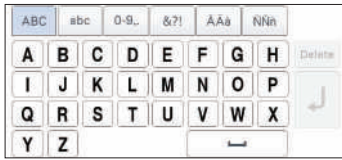

29 ABCDE

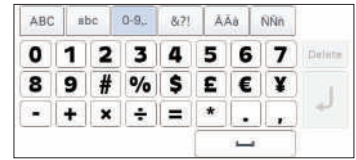

Summary of Embroidery Patterns
 Sommaire des motifs de broderie
 Riepilogo dei ricami
 Resumo de padrões de bordado

Übersicht der Stickmuster
 Overzicht van borduurpatronen
 Resumen de diseños de bordado
 Обзор дизайнов для вышивания

30
 ABCDE

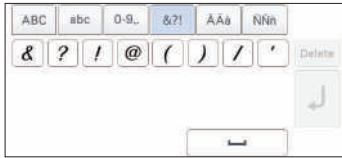
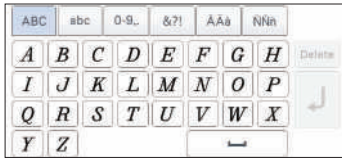

31
 ABCDE

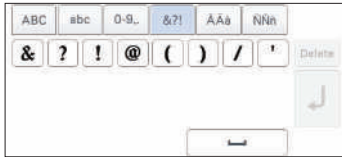
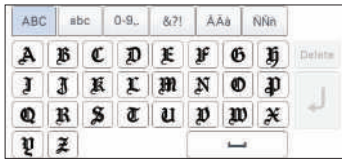

32
 ABCDE

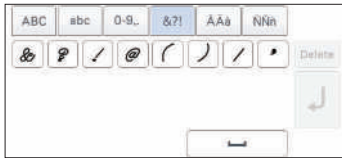

33
 ABCDEFGH

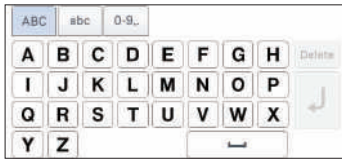

あいう

Katakana characters: One of the character sets of Japanese.
 Katakana-Zeichen: Einer der Zeichensätze für Japanisch.
 Caractères Katakana : l'un des types de caractères japonais.
 Katakana-tekens: één van de Japanse tekensets.
 Caratteri Katakana: uno dei set di caratteri della lingua giapponese.
 Caracteres Katakana: uno de los grupos de caracteres del japonés.
 Caracteres katakana: um dos sistemas de caracteres do alfabeto japonês.
 Катакана: один из наборов символов (азбука) в японском языке.

Hiragana characters: One of the character sets of Japanese.
 Hiragana-Zeichen: Einer der Zeichensätze für Japanisch.
 Caractères Hiragana : l'un des types de caractères japonais.
 Hiragana-tekens: één van de Japanse tekensets.
 Caratteri Hiragana: uno dei set di caratteri della lingua giapponese.
 Caracteres Hiragana: uno de los grupos de caracteres del japonés.
 Caracteres hiragana: um dos sistemas de caracteres do alfabeto japonês.
 Хирагана: один из наборов символов (азбука) в японском языке.

Arabic numerals, Japanese Kanji numerals
 Arabische Ziffern, japanische Kanji-Ziffern
 Chiffres arabes, chiffres Kanji japonais
 Arabische cijfers, Japanse Kanji-cijfers
 Numeri arabi, numeri Kanji giapponesi
 Números arábigos, números Kanji japoneses
 Numerais arábicos, numerais japoneses em kanji
 Арабские цифры и иероглифы кандзи

Kanji characters often used in daily life / symbols.
 Im Alltag häufig verwendete Kanji-Zeichen / Symbole.
 Les caractères Kanji sont souvent utilisés dans la vie de tous les jours / symboles.
 Kanji-tekens: vaak gebruikt in het dagelijks leven / symbolen.
 Caratteri Kanji spesso utilizzati nella vita quotidiana / simboli.
 Los caracteres Kanji se utilizan a menudo en la vida diaria / como símbolos.
 Caracteres kanji utilizados frecuentemente no cotidiano/símbolos.
 Иероглифы кандзи часто используются в повседневной жизни или как символы.

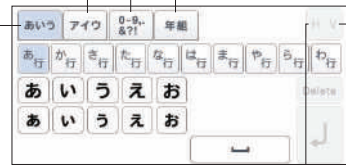

Horizontal
 Horizontal
 Horizontal
 Horizontal
 Orizzontale
 Horizontal
 Horizontal
 По горизонтали

Vertical
 Vertikal
 Vertical
 Vertical
 Verticale
 Vertical
 Vertical
 По вертикали

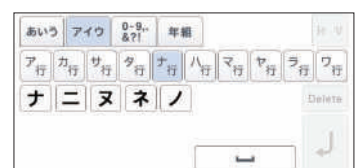
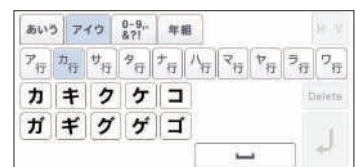
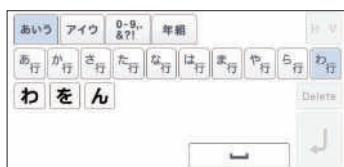
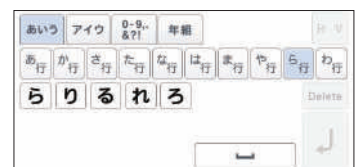
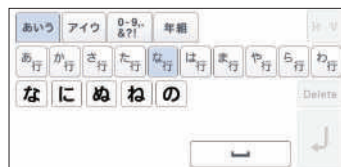
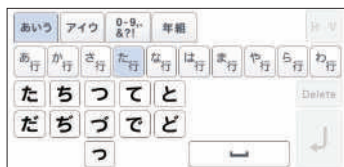
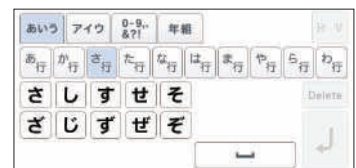
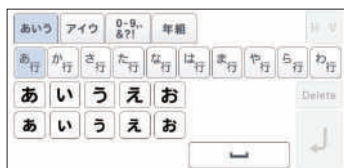

Summary of Embroidery Patterns
 Sommaire des motifs de broderie
 Riepilogo dei ricami
 Resumo de padrões de bordado

Übersicht der Stickmuster
 Overzicht van borduurpatronen
 Resumen de diseños de bordado
 Обзор дизайнов для вышивания

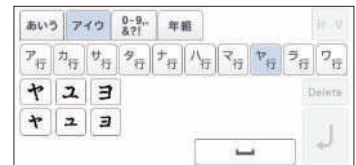
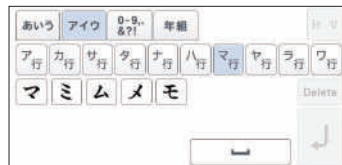
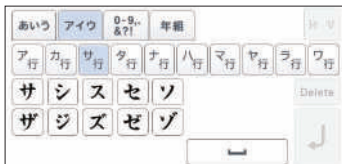
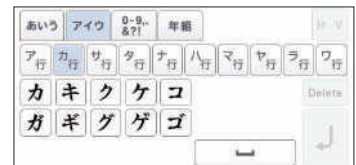
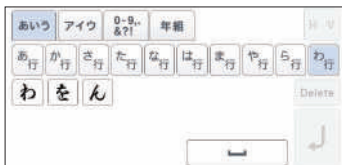
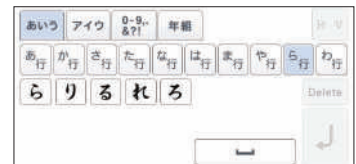
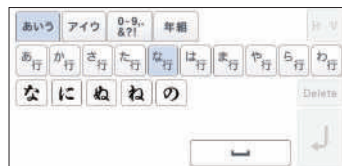
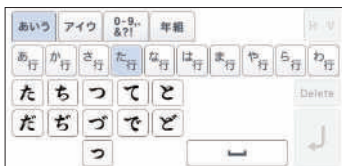
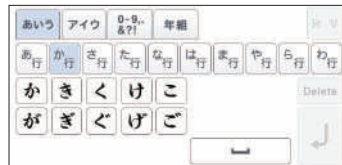
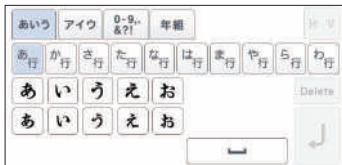
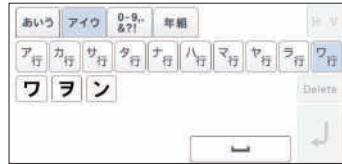

35
 あいう



36
あいう

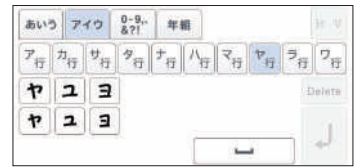
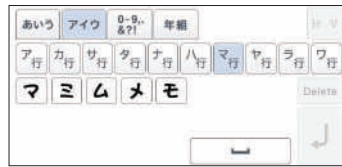
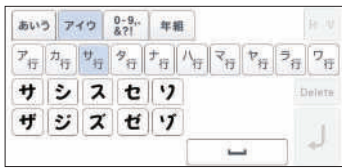
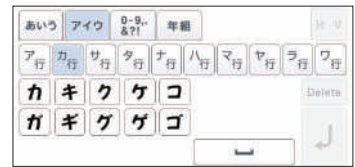
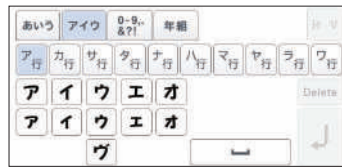
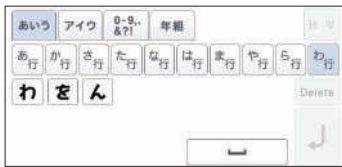
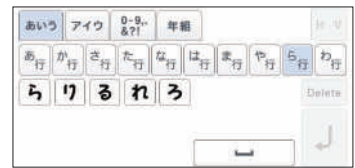
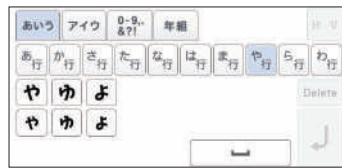
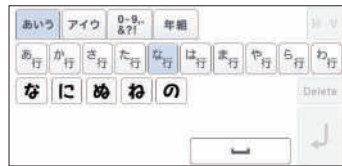
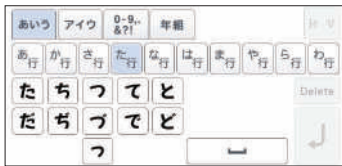
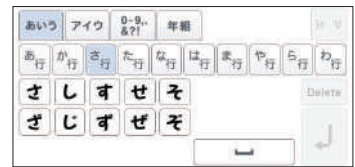
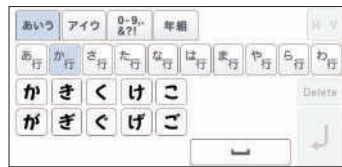
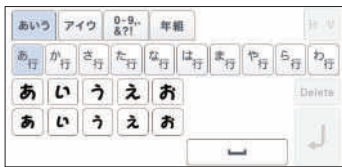

- ◆ Decorative Alphabet Patterns
- ◆ Motifs d'alphabet décoratif
- ◆ Ricami Alfabeto decorativo
- ◆ Padrões de alfabeto decorativo

- ◆ Dekor-Buchstabenmuster
- ◆ Decoratieve sierlettertypen
- ◆ Patrones de alfabeto decorativo
- ◆ Декоративные шрифты



- Floral Alphabet (Gold)
- Alphabet floral (doré)
- Alfabeto floreale (dorato)
- Alfabeto floral (dourado)

- Blumenbuchstaben (Gold)
- Bloemenalfabet (goud)
- Alfabeto floral (dorado)
- Цветочный шрифт (золотой)

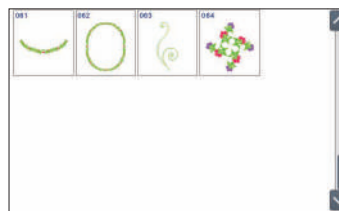
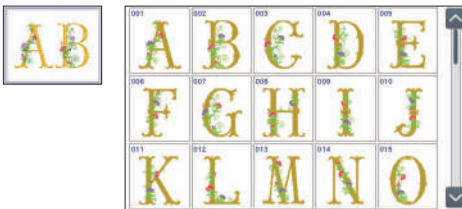

- Floral Alphabet (Blue)
- Alphabet floral (bleu)
- Alfabeto floreale (blu)
- Alfabeto floral (azul)

- Blumenbuchstaben (Blau)
- Bloemenalfabet (blauw)
- Alfabeto floral (azul)
- Цветочный шрифт (голубой)

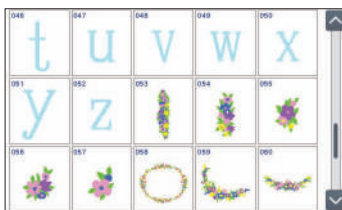
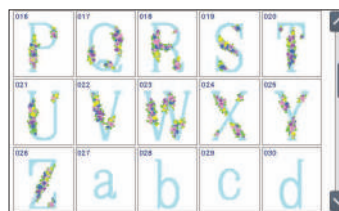

- Floral Alphabet
- Alphabet floral
- Alfabeto floreale
- Alfabeto floral



- Blumenbuchstaben
- Bloemenalfabet (intern)
- Alfabeto floral
- Цветочный шрифт

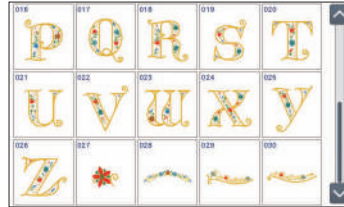

- Split Monogram
- Monogramme fractionné
- Monogramma diviso
- Monograma dividido



- Geteiltes Monogramm
- Gesplitst monogram
- Monograma dividido
- Разделенные монограммы



- Calligraphy
- Calligraphie
- Calligrafia
- Caligrafia



- Kalligrafie
- Kalligrafie
- Caligrafía
- Каллиграфический шрифт

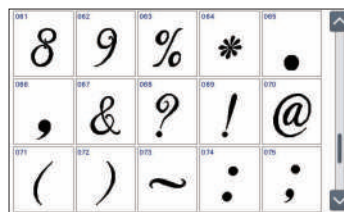
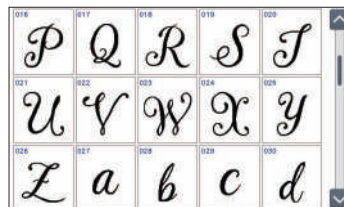

- Vine Alphabet
- Alphabet vigné
- Alfabeto fiorato
- Alfabeto decorativo estilo vinha

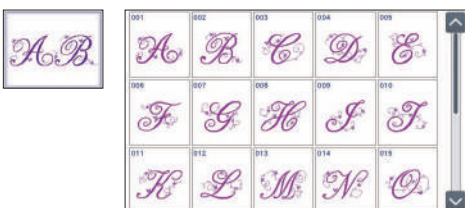

- Weinrebenbuchstaben
- Alfabet met wijnrank
- Alfabeto floral
- Шрифт с растительным узором

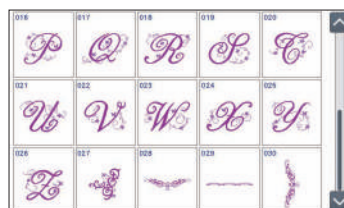

- Line Alphabet
- Alphabet « lignes »
- Alfabeto lineare
- Alfabeto de linhas



- Linienbuchstaben
- Alfabet met belijning
- Alfabeto lineal
- Вензельный шрифт



- Renaissance Alphabet
- Alphabet Renaissance
- Alfabeto rinascimentale
- Alfabeto renascentista



- Renaissancebuchstaben
- Renaissance alfabet
- Alfabetico renacentista
- Шрифт "Ренессанс"



- Vintage Alphabet
- Alphabet vintage (rétro)
- Alfabeto vintage
- Alfabeto vintage

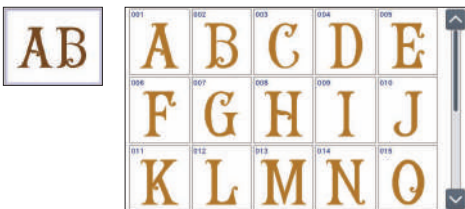

- Vintage Buchstaben
- Alfabet in retrostijl
- Alfabeto antiguo
- Винтажный шрифт

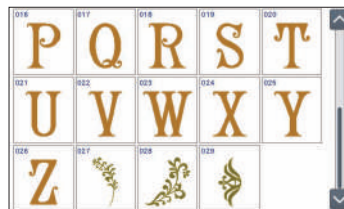

- Appliqué Alphabet
- Alphabet appliqué
- Alfabeto in appliqué
- Alfabeto para apliques

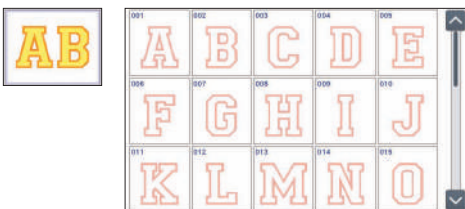

- Buchstabenapplikationen
- Blokletter applicatie alfabet
- Diseños alfabéticos con adornos
- Шрифт для аппликации

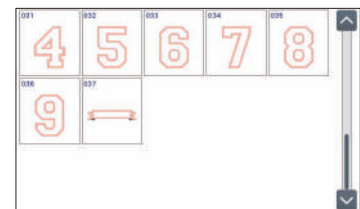

- Block Alphabet
- Alphabet en bloc
- Alfabeto a blocchi
- Alfabeto sólido

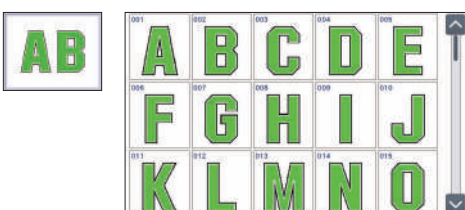

- Blockbuchstaben
- Blokletter alfabet
- Alfabeto sólido
- Рубленный шрифт

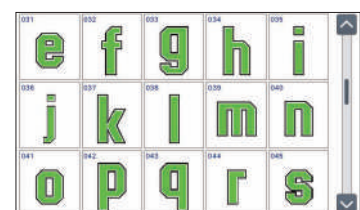
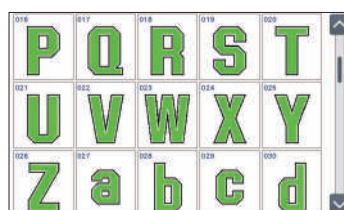

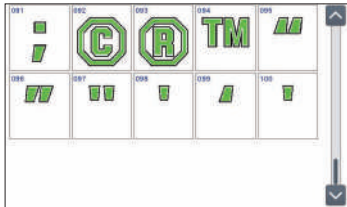
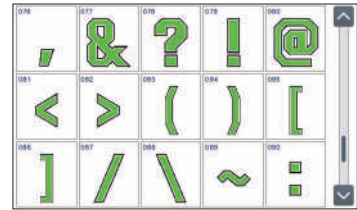
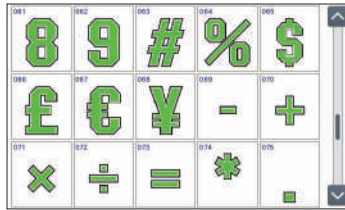
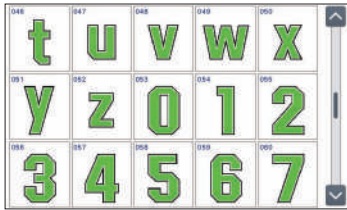

- Striped Alphabet
- Alphabet rayé
- Alfabeto a strisce
- Alfabeto listrado

- Gestreifte Buchstaben
- Gestreept alfabet
- Alfabeto rayado
- Шрифт “Полоска”

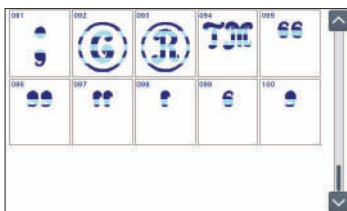
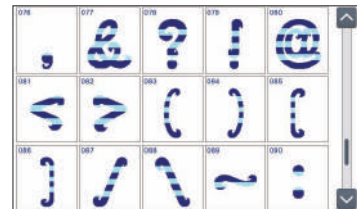
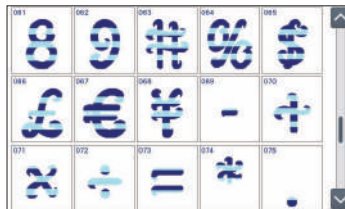
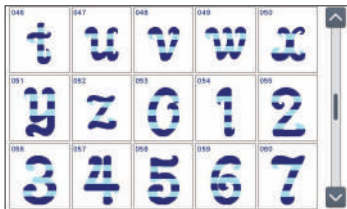
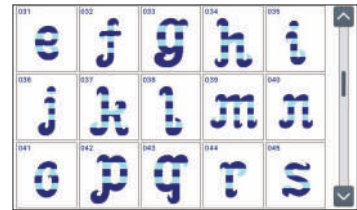
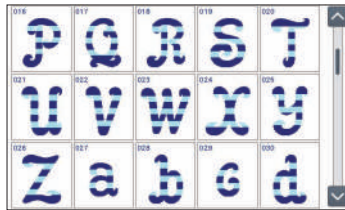
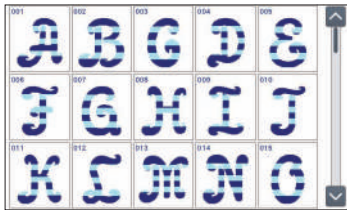

- Greek Alphabet
- Motifs alphabet grec
- Alfabeto greco
- Alfabeto grego

- Buchstabenmuster des griechischen Alphabets
- Grieks alfabet
- Costuras de caracteres alfabéticos griegos
- Греческий шрифт



- Appliqué Greek Alphabet
- Alphabet grec Appliqué
- Alfabeto greco in appliqué
- Alfabeto greco para apliques

- Griechische Buchstaben für Applikationen
- Applicatie Grieks alfabet
- Alfabeto griego con adornos
- Греческий шрифт для аппликации



- ◆ Quilting border patterns
- ◆ Motifs de bordure en points quilting (courpointe)
- ◆ Ricami per bordi per trapuntatura
- ◆ Padrões de arremate de acolchoados

- ◆ Quiltrandmuster
- ◆ Quilt randpatronen
- ◆ Patrones de borde de acolchado
- ◆ Дизайны бордюрной вышивки для квилтинга

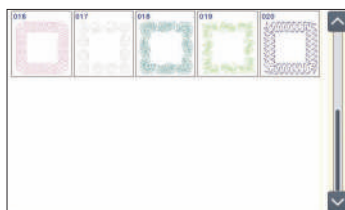
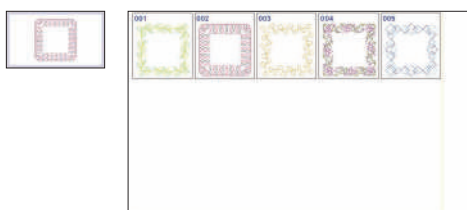

Embroidery Pattern Color Change Table

Tableau de changement des couleurs des motifs de broderie

Tabella dei cambi colore dei ricami

Tabela de alteração de cor de padrões de bordado

Stickdesign-Farbtabelle

Kleurenvolgorde voor de borduurpatronen

Tabla de cambio de color para patrones de bordado

Таблицы цветов нитей для вышивок

Embroidery time and size of each design in this guide may differ from the information on the machine display. Please use as a reference purpose only. The color numbers in this guide are for the Embroidery thread brand unless otherwise noted.

- Patterns marked with ● have been rotated. Check your design placement prior to embroidering.
- ★ Refer to the operation manual for the embroidery machine for details on how to embroider appliqués.

La durée de broderie et la taille de chaque motif présenté dans ce guide peuvent différer des informations affichées à l'écran de la machine. Merci de les utiliser à titre de référence uniquement. Les numéros des couleurs dans ce guide correspondent à la marque de fils à broder, sauf indication contraire.

- Les motifs signalés par ● ont été pivotés. Vérifiez l'emplacement de votre motif avant de commencer à broder.
- ★ Reportez-vous au manuel d'instructions de la machine à broder pour plus d'informations sur la broderie des appliqués.

Il tempo di ricamo e le dimensioni di ciascun ricamo in questa guida possono differire dalle informazioni sul display della macchina. Si prega di utilizzare solo come riferimento.

Salvo diversa indicazione, i numeri dei colori riportati in questa guida corrispondono alla marca del filo per ricamo.

- I ricami contrassegnati dal simbolo ● appaiono ruotati. Prima di procedere a ricamare, verificare la posizione del ricamo.
- ★ Consultare il manuale di istruzioni della macchina per ricamare per i dettagli relativi al ricamo di appliqué.

O tempo e o tamanho do bordado de cada desenho neste guia podem ser diferentes das informações exibidas na tela da máquina. Use apenas com propósito de referência.

Os números de cores neste guia são para marcas de linha de bordar, a menos que indicado de outra forma.

- Os padrões marcados com ● foram invertidos. Verifique o posicionamento do seu desenho antes de bordar.

- ★ Consulte o manual de operações da máquina de bordar para obter detalhes sobre como bordar apliques.

Die Stickzeit und die Größe jedes Designs in dieser Anleitung können von den Informationen im Display abweichen. Bitte verwenden Sie die Angaben nur als Referenz.

Die Farbnummern in dieser Anleitung beziehen sich auf die Stickgarnmarke, sofern nicht anders angegeben.

- Muster, die mit ● gekennzeichnet sind, wurden gedreht. Überprüfen Sie die Platzierung Ihres Designs, bevor Sie mit Stickern beginnen.
- ★ Weitere Hinweise zum Stickern von Applikationen finden Sie in der Bedienungsanleitung der Stickmaschine.

De informatie in deze handleiding over de borduurtijd en de afmeting van het borduurpatroon kan afwijken van de weergave op het beeldscherm van de machine. Gelieve de informatie alleen te gebruiken als richtlijn.

De kleurnummers in deze handleiding verwijzen naar een borduurgarenmerk tenzij anders vermeld.

- Patronen die zijn gemarkeerd met ● zijn gerooteerd. Controleer de plaats van uw ontwerp voordat u gaat borduren.

- ★ Raadpleeg de bedieningshandleiding bij de borduurmachine voor gedetailleerde uitleg over het borduren van applicaties.

El tiempo de bordado y el tamaño de cada diseño en esta guía pueden diferir de la información en la pantalla de la máquina. Por favor, use solo como referencia.

Los números de colores en esta guía se refieren a la marca de hilos de Bordado, a menos que se indique lo contrario.

- Los patrones marcado con ● se han girado. Compruebe la colocación del diseño antes de bordar.

- ★ Consulte el manual de instrucciones de la máquina de bordar si desea más información sobre cómo border apliques.

Время вышивания и размер каждого дизайна в этом руководстве может отличаться от информации на дисплее машины. Используйте эти данные только для справки.

Номера цветов, указанные в данном руководстве, относятся к маркам нитей для вышивания, если не указано иное.

- Рисунки, отмеченные знаком ●, повернуты. Проверьте расположение рисунка перед началом вышивания.

- ★ Инструкции по вышиванию аппликаций приведены в руководстве пользователя машины.

◆ Embroidery Patterns

◆ Motifs de broderie

◆ Schema colori dei ricami

◆ Padrões de bordado

- "Featured" Designs
- Motifs « à la Une »
- Ricami "inclusi"
- Desenhos "em destaque"

◆ Stickmuster

◆ Borduurpatronen

◆ Patrones de bordado

◆ Дизайны для вышивания

- „Vorgestellte“ Stickmuster
- Specifieke ontwerpen
- Diseños "Destacados"
- Дизайны "Тематические"



● No. 001

Order to embroider
Stickreihenfolge
Séquence de broderie
Borduurvolgorde
Sequenza dei cambi colore del ricamo
Orden para el bordador
Ordem para bordar
Порядок вышивания

Embroidery thread color
Stickgarnfarbe
Couleur du fil de broderie
Kleur borduurgaren
Colore filo ricamo
Color del hilo de bordado
Cor da linha de bordar
Цвет нити для вышивания

92 min	
1	(001)
2	(804)
3	(019)
4	(804)
5	(085)
6	(126)
7	(070)
8	(086)
9	(085)
10	(206)
11	(513)
12	(005)
13	(001)

↓ 195.9 mm
↔ 355.6 mm

Time required for embroidering
Stickdauer
Durée requise pour broder
Tijd benodigd voor het borduren
Tempo di ricamo necessario
Tiempo requerido para el bordado
Tempo necessário para bordar
Время, необходимое для вышивания

Embroidery thread color number
Stickgarn-Farbnummer
Numéro de couleur du fil de broderie
Kleurnummer borduurgaren
Numero del colore del filo da ricamo
Número de color del hilo de bordado
Número da cor da linha de bordar
Номер цвета нити для вышивания

Embroidery size
Größe der Stickerei
Taille de la broderie
Afmeting borduurmotief
Dimensioni del ricamo
Tecla de tamaño
Tamanho do bordado
Размер вышивки

● No. 002

17 min

- 1 (804)
- 2 (070)
- 3 (399)

↓ 153.6 mm
↔ 355.3 mm



No. 004

53 min

- 1 (405)
- 2 (534)
- 3 (086)

↓ 195.8 mm
↔ 357.8 mm

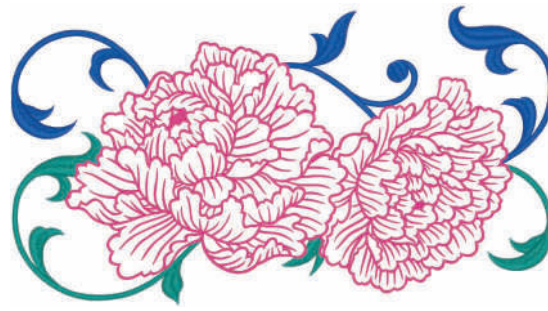

No. 005

8 min

- 1 (405)
- 2 (030)

↓ 197.0 mm
↔ 64.3 mm



No. 007



● No. 003



● No. 006



85 min

- | | |
|---------|----------|
| 1 (070) | 8 (502) |
| 2 (612) | 9 (328) |
| 3 (542) | 10 (206) |
| 4 (612) | 11 (027) |
| 5 (810) | 12 (010) |
| 6 (027) | 13 (328) |
| 7 (328) | |

↓ 189.2 mm ↔ 333.4 mm

195 min		
1 (534)	17 (086)	33 (030)
2 (515)	18 (807)	34 (206)
3 (085)	19 (534)	35 (405)
4 (079)	20 (515)	36 (534)
5 (086)	21 (085)	37 (515)
6 (807)	22 (079)	38 (085)
7 (534)	23 (086)	39 (079)
8 (515)	24 (807)	40 (086)
9 (085)	25 (534)	41 (807)
10 (079)	26 (515)	42 (534)
11 (086)	27 (085)	43 (515)
12 (807)	28 (079)	44 (085)
13 (534)	29 (086)	45 (079)
14 (515)	30 (807)	46 (086)
15 (085)	31 (001)	47 (807)
16 (079)	32 (405)	

↓ 195.2 mm ↔ 342.2 mm

171 min	
1 (030)	14 (513)
2 (509)	15 (206)
3 (612)	16 (010)
4 (804)	17 (027)
5 (027)	18 (328)
6 (328)	19 (509)
7 (513)	20 (513)
8 (328)	21 (328)
9 (206)	22 (206)
10 (027)	23 (027)
11 (010)	24 (205)
12 (328)	25 (328)
13 (509)	

↓ 195.4 mm ↔ 354.8 mm



No. 008

28 min		
1 (534)	9 (126)	17 (019)
2 (542)	10 (017)	18 (126)
3 (534)	11 (534)	19 (348)
4 (017)	12 (399)	20 (030)
5 (030)	13 (030)	21 (534)
6 (019)	14 (534)	22 (019)
7 (126)	15 (017)	23 (017)
8 (019)	16 (126)	

↓ 130.7 mm ↔ 354.0 mm

No. 009



137 min			
1 (001)	17 (707)	33 (810)	49 (001)
2 (010)	18 (810)	34 (804)	50 (804)
3 (124)	19 (124)	35 (502)	51 (124)
4 (810)	20 (810)	36 (542)	52 (010)
5 (804)	21 (707)	37 (001)	53 (810)
6 (502)	22 (001)	38 (707)	54 (124)
7 (542)	23 (010)	39 (502)	55 (707)
8 (001)	24 (124)	40 (399)	56 (001)
9 (707)	25 (810)	41 (804)	57 (017)
10 (010)	26 (804)	42 (707)	58 (804)
11 (124)	27 (502)	43 (010)	59 (502)
12 (810)	28 (542)	44 (124)	60 (542)
13 (804)	29 (001)	45 (707)	61 (001)
14 (502)	30 (707)	46 (017)	62 (707)
15 (542)	31 (010)	47 (804)	
16 (001)	32 (124)	48 (707)	

↓ 176.3 mm ↔ 350.9 mm

No. 010



103 min			
1 (001)	13 (001)	25 (804)	37 (017)
2 (810)	14 (010)	26 (810)	38 (804)
3 (124)	15 (017)	27 (399)	39 (810)
4 (017)	16 (542)	28 (707)	40 (124)
5 (804)	17 (001)	29 (001)	41 (707)
6 (399)	18 (010)	30 (010)	42 (001)
7 (707)	19 (707)	31 (124)	43 (017)
8 (010)	20 (804)	32 (810)	44 (804)
9 (017)	21 (707)	33 (804)	45 (542)
10 (542)	22 (001)	34 (542)	46 (502)
11 (001)	23 (542)	35 (707)	47 (399)
12 (707)	24 (124)	36 (001)	48 (707)

↓ 162.6 mm ↔ 349.7 mm

No. 011



37 min	
1 (124)	11 (810)
2 (810)	12 (804)
3 (804)	13 (542)
4 (542)	14 (502)
5 (502)	15 (017)
6 (017)	16 (010)
7 (010)	17 (001)
8 (001)	18 (707)
9 (707)	19 (399)
10 (124)	20 (707)

↓ 97.1 mm ↔ 122.6 mm

No. 012



27 min	
1 (214)	
2 (085)	
3 (019)	
4 (542)	
5 (085)	
6 (405)	

↓ 122.9 mm
↔ 151.0 mm

No. 017



8 min	
1 (869)	
2 (707)	

↓ 195.4 mm
↔ 53.9 mm

No. 013



15 min	
1 (214)	
2 (405)	
3 (019)	
4 (542)	

↓ 161.3 mm
↔ 58.0 mm

No. 018



13 min	
1 (058)	
2 (707)	
3 (058)	
4 (869)	
5 (707)	

↓ 54.9 mm
↔ 124.8 mm

No. 014



6 min	
1 (019)	
2 (085)	

↓ 57.6 mm
↔ 57.6 mm

No. 019



No. 015



36 min	
1 (399)	
2 (515)	
3 (517)	
4 (107)	
5 (807)	
6 (001)	
7 (900)	
8 (001)	
9 (515)	
10 (517)	
11 (107)	
12 (807)	
13 (086)	
14 (001)	
15 (900)	
16 (001)	

↓ 195.6 mm
↔ 47.6 mm

34 min	
1 (001)	11 (126)
2 (017)	12 (206)
3 (502)	13 (502)
4 (126)	14 (206)
5 (399)	15 (085)
6 (206)	16 (017)
7 (126)	17 (502)
8 (804)	18 (704)
9 (085)	19 (001)
10 (017)	

↓ 56.0 mm ↔ 293.9 mm

No. 016



22 min	
1 (399)	
2 (515)	
3 (517)	
4 (107)	
5 (807)	
6 (086)	
7 (001)	
8 (900)	

↓ 53.9 mm
↔ 112.4 mm

No. 020



16 min	
1 (900)	
2 (001)	
3 (208)	
4 (513)	
5 (612)	
6 (019)	
7 (086)	
8 (807)	

↓ 49.6 mm
↔ 120.5 mm

No. 021



26 min	
1	(515)
2	(030)
3	(001)
4	(005)
5	(019)
6	(126)
7	(707)
8	(126)
9	(005)
10	(323)
11	(017)
12	(206)
13	(030)
14	(019)
15	(515)
16	(019)
17	(030)
18	(005)
19	(001)
20	(707)

↓ 190.6 mm
 ↔ 62.2 mm

No. 022



11 min	
1	(001)
2	(019)
3	(323)
4	(214)
5	(030)
6	(206)
7	(058)
8	(126)
9	(017)

↓ 53.6 mm
 ↔ 56.7 mm

No. 023



21 min	
1	(086)
2	(307)
3	(206)
4	(001)
5	(017)
6	(085)
7	(707)
8	(086)
9	(515)
10	(323)
11	(206)
12	(001)
13	(307)
14	(323)
15	(005)
16	(707)

↓ 174.4 mm
 ↔ 58.1 mm

No. 024



11 min	
1	(126)
2	(513)
3	(542)
4	(001)
5	(005)
6	(124)
7	(542)
8	(058)
9	(126)
10	(086)
11	(019)
12	(206)

↓ 55.2 mm
 ↔ 49.0 mm

No. 025



49 min	
1	(517)
2	(515)
3	(810)
4	(030)
5	(209)
6	(620)
7	(869)
8	(328)
9	(517)
10	(515)
11	(214)
12	(328)
13	(517)
14	(515)
15	(030)
16	(337)
17	(620)
18	(869)
19	(810)
20	(030)
21	(209)
22	(517)
23	(515)
24	(869)
25	(030)
26	(209)
27	(517)
28	(515)
29	(620)
30	(328)
31	(620)
32	(517)
33	(515)
34	(030)
35	(209)
36	(810)
37	(030)
38	(620)
39	(869)

↓ 138.9 mm ↔ 277.0 mm

No. 026



21 min	
1	(517)
2	(515)
3	(030)
4	(337)
5	(030)
6	(209)
7	(517)
8	(515)
9	(869)
10	(620)
11	(030)
12	(209)
13	(810)
14	(030)
15	(214)
16	(328)
17	(517)
18	(515)
19	(810)
20	(869)

↓ 142.8 mm ↔ 120.7 mm

No. 027



18 min	
1	(030)
2	(209)
3	(517)
4	(515)
5	(214)
6	(328)
7	(810)
8	(869)
9	(517)
10	(515)
11	(214)
12	(328)
13	(810)
14	(869)
15	(810)
16	(030)
17	(209)

↓ 195.3 mm ↔ 59.3 mm

No. 028



4 min	
1	(030)
2	(209)
3	(517)
4	(515)

↓ 47.1 mm
 ↔ 41.3 mm

No. 029



No. 026

46 min					
1	(019)	9	(613)	17	(613)
2	(328)	10	(807)	18	(807)
3	(534)	11	(328)	19	(214)
4	(613)	12	(534)	20	(534)
5	(019)	13	(019)	21	(019)
6	(328)	14	(613)	22	(328)
7	(214)	15	(807)	23	(019)
8	(807)	16	(328)	24	(534)

↓ 195.2 mm ↔ 342.2 mm

No. 030



2 min	
1	(328)
2	(613)

↓ 12.5 mm
 ↔ 95.6 mm

No. 031



4 min	
1	(328)
2	(613)

↓ 29.2 mm
 ↔ 95.7 mm

No. 032



5 min	
1	(534)
2	(019)
3	(328)
4	(019)
5	(534)

↓ 56.3 mm
 ↔ 44.5 mm



No. 033

15 min	
1	(348)
2	(328)

↓ 141.8 mm
↔ 142.9 mm



No. 034

6 min	
1	(399)

↓ 121.0 mm
↔ 113.9 mm

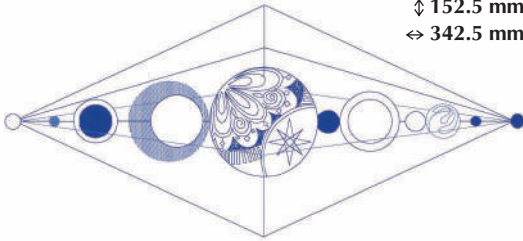

No. 035

13 min	
1	(070)
2	(406)
3	(070)
4	(406)

↓ 152.5 mm
↔ 342.5 mm



No. 036

7 min			
1	(607)	5	(079)
2	(420)	6	(086)
3	(206)	7	(019)
4	(214)	8	(007)

↓ 24.6 mm ↔ 114.6 mm



No. 038

30 min			
1	(079)	7	(206)
2	(086)	8	(214)
3	(019)	9	(079)
4	(607)	10	(086)
5	(420)	11	(007)
6	(001)	12	(420)

↓ 59.0 mm ↔ 192.3 mm



No. 037

6 min			
1	(607)	5	(079)
2	(420)	6	(086)
3	(206)	7	(007)
4	(214)	8	(420)

↓ 38.5 mm ↔ 64.0 mm



No. 039

11 min	
1	(399)
2	(614)
3	(007)
4	(900)
5	(399)
6	(001)
7	(005)

↓ 47.2 mm
↔ 85.3 mm



No. 040

10 min	
1	(107)
2	(007)
3	(214)
4	(328)

↓ 66.6 mm
↔ 68.8 mm

- "Steam Punk" Designs
- Motifs « steampunk »
- Ricami "steampunk"
- Desenhos "Steam Punk"

- „Steampunk“-Stickmuster
- Steampunk ontwerpen
- Diseños "Steam Punk"
- Дизайны "СТИМПУНК"



No. 001



110 min			
1	(328)	9	(542)
2	(058)	10	(058)
3	(005)	11	(817)
4	(704)	12	(704)
5	(328)	13	(323)
6	(058)	14	(058)
7	(328)	15	(869)
8	(005)	16	(328)
17	(058)	25	(058)
18	(328)	26	(707)
19	(058)	27	(704)
20	(817)	28	(214)
21	(542)	29	(058)
22	(704)		
23	(005)		
24	(323)		

↓ 195.9 mm ↔ 355.4 mm

No. 002



30 min			
1	(058)	9	(005)
2	(005)	10	(058)
3	(328)	11	(005)
4	(704)	12	(707)
5	(869)	13	(542)
6	(323)	14	(707)
7	(058)	15	(005)
8	(323)		

↓ 114.7 mm ↔ 126.7 mm

No. 003



53 min			
1	(843)	5	(058)
2	(328)	6	(328)
3	(058)	7	(058)
4	(328)	8	(328)
9	(058)	13	(817)
10	(214)	14	(058)
11	(707)		
12	(005)		

↓ 167.1 mm ↔ 231.4 mm



No. 004

37 min			
1 (005)	4 (323)	7 (005)	10 (058)
2 (817)	5 (328)	8 (058)	11 (704)
3 (058)	6 (058)	9 (328)	12 (707)

↓ 115.7 mm ↔ 231.0 mm



No. 007

52 min	
1 (607)	8 (900)
2 (542)	9 (807)
3 (807)	
4 (900)	
5 (807)	
6 (612)	
7 (542)	
8 (900)	
9 (807)	

↓ 195.8 mm
 ↔ 194.7 mm



No. 005

32 min				
1 (328)	5 (005)	9 (707)	13 (058)	17 (542)
2 (058)	6 (704)	10 (005)	14 (869)	18 (707)
3 (328)	7 (707)	11 (704)	15 (005)	
4 (058)	8 (817)	12 (328)	16 (058)	

↓ 58.8 mm ↔ 271.2 mm



No. 008

50 min			
1 (399)	3 (804)		
2 (001)	4 (399)		

↓ 127.5 mm ↔ 325.4 mm



No. 006

15 min	
1 (612)	4 (406)
2 (406)	5 (900)
3 (900)	
4 (406)	
5 (900)	

↓ 96.8 mm
 ↔ 303.0 mm

- "Quilt" Designs
- Motifs pour quilting (courtepointe)
- Ricami "per quilting"
- Desenhos "para acolchoados"

- „Quilt“-Stickmuster
- Quilt ontwerpen
- Diseños "Acolchado"
- Дизайны "Квилт"

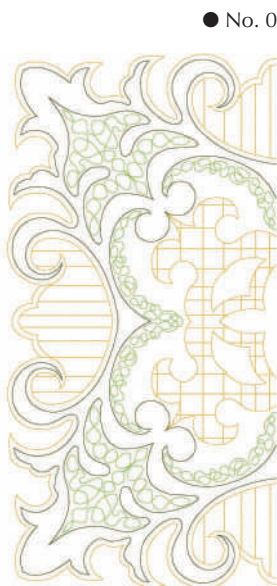

● No. 001

17 min		
1 (517)	2 (513)	3 (214)

↓ 176.6 mm
 ↔ 352.8 mm



No. 002

5 min	
1 (517)	2 (214)

↓ 176.0 mm
 ↔ 88.8 mm



No. 003

7 min		
1 (517)	2 (030)	3 (214)

↓ 92.4 mm
 ↔ 92.4 mm



● No. 004

22 min			
1 (804)	2 (399)	3 (804)	4 (542)

↓ 177.8 mm
 ↔ 354.9 mm

● No. 005

23 min

- 1 (804)
- 2 (399)
- 3 (804)
- 4 (542)

↓ 175.2 mm
 ↔ 354.5 mm



No. 009

5 min

- 1 (019)
- 2 (509)
- 3 (209)
- 4 (509)
- 5 (209)

↓ 92.0 mm
 ↔ 92.5 mm



No. 010

10 min

- 1 (415)
- 2 (620)
- 3 (807)

↓ 195.4 mm
 ↔ 195.4 mm

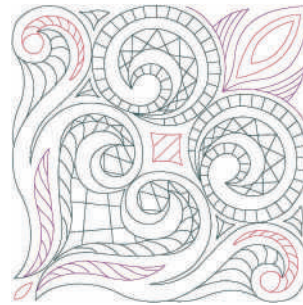

No. 006

10 min

- 1 (804)
- 2 (399)
- 3 (804)
- 4 (399)
- 5 (542)

↓ 176.5 mm
 ↔ 176.5 mm



No. 011

15 min

- 1 (807)

↓ 172.5 mm
 ↔ 344.9 mm



No. 007

13 min

- 1 (019)
- 2 (005)
- 3 (509)
- 4 (019)
- 5 (509)

↓ 194.9 mm
 ↔ 194.6 mm



No. 012

8 min

- 1 (807)

↓ 194.5 mm
 ↔ 264.1 mm



No. 008

7 min

- 1 (005)
- 2 (209)
- 3 (509)
- 4 (209)

↓ 195.6 mm
 ↔ 195.6 mm

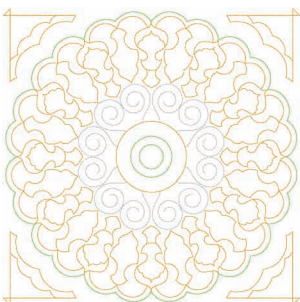

No. 013

12 min

- 1 (030)

↓ 176.9 mm
 ↔ 352.8 mm



No. 014

11 min	
1	(534)
↓ 176.1 mm	
↔ 351.3 mm	

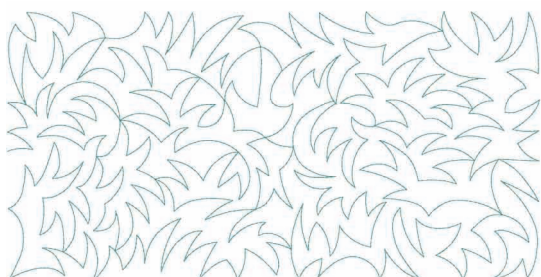

No. 019

14 min	
1	(005)
2	(070)
3	(704)
4	(612)
↓ 194.2 mm	
↔ 194.2 mm	



No. 015

18 min	
1	(348)
2	(085)
3	(086)
4	(513)
5	(085)
6	(086)
7	(348)
↓ 173.6 mm	
↔ 348.3 mm	



No. 020

14 min	
1	(019)
2	(509)
3	(209)
4	(019)
5	(509)
↓ 193.2 mm	
↔ 193.6 mm	



No. 016

16 min	
1	(107)
2	(005)
3	(415)
4	(214)
↓ 188.7 mm	
↔ 191.2 mm	



No. 021

12 min	
1	(107)
2	(007)
3	(107)
↓ 194.4 mm	
↔ 193.6 mm	

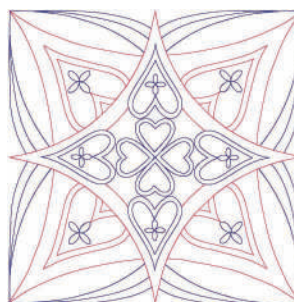

No. 017

2 min	
1	(330)
↓ 44.2 mm	
↔ 162.8 mm	



No. 022

15 min	
1	(817)
2	(005)
3	(810)
4	(620)
5	(070)
↓ 191.2 mm	
↔ 191.2 mm	

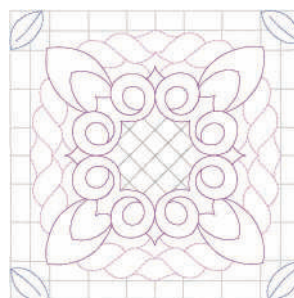

No. 018

3 min	
1	(214)
2	(330)
↓ 95.3 mm	
↔ 83.5 mm	



- "Craft" Designs
- Motifs « artisanaux »
- Ricami "creativi"
- Desenhos "artesanais"

- „Craft“-Stickmuster
- Craft- en hobbyborduurpatronen
- Diseños "Artesanales"
- Дизайны "Декор"



● No. 001



78 min			
1	(070)	21	(086)
2	(085)	22	(900)
3	(086)	23	(613)
4	(085)	24	(070)
5	(810)	25	(406)
6	(085)	26	(900)
7	(206)	27	(206)
8	(810)	28	(542)
9	(085)	29	(509)
10	(086)	30	(086)
11	(206)	31	(206)
12	(542)	32	(509)
13	(070)	33	(613)
14	(613)	34	(542)
15	(406)	35	(070)
16	(542)	36	(406)
17	(509)	37	(509)
18	(086)	38	(613)
19	(206)	39	(086)
20	(070)	40	(206)

↓ 168.3 mm ↔ 355.3 mm

● No. 004



80 min			
1	(030)	16	(019)
2	(001)	17	(307)
3	(337)	18	(214)
4	(307)	19	(307)
5	(019)	20	(019)
6	(214)	21	(214)
7	(307)	22	(517)
8	(019)	23	(812)
9	(214)	24	(515)
10	(307)	25	(058)
11	(058)	26	(001)
12	(001)	27	(307)
13	(030)	28	(030)
14	(337)	29	(214)
15	(307)	30	(058)

↓ 110.8 mm ↔ 244.8 mm

● No. 002



93 min			
1	(085)	19	(542)
2	(086)	20	(070)
3	(085)	21	(406)
4	(124)	22	(086)
5	(085)	23	(900)
6	(124)	24	(542)
7	(085)	25	(086)
8	(086)	26	(085)
9	(124)	27	(612)
10	(070)	28	(070)
11	(612)	29	(086)
12	(406)	30	(406)
13	(509)	31	(086)
14	(542)	32	(804)
15	(900)	33	(070)
16	(086)	34	(804)
17	(612)	35	(086)
18	(509)		

↓ 195.8 mm ↔ 351.9 mm

No. 005



87 min			
1	(515)	35	(843)
2	(027)	36	(010)
3	(513)	37	(810)
4	(058)	38	(010)
5	(208)	39	(323)
6	(070)	40	(513)
7	(019)	41	(534)
8	(209)	42	(019)
9	(208)	43	(208)
10	(800)	44	(843)
11	(405)	45	(010)
12	(058)	46	(810)
13	(513)	47	(010)
14	(534)	48	(323)
15	(019)	49	(070)
16	(208)	50	(208)
17	(843)	51	(001)
18	(010)	52	(058)
19	(810)	53	(010)
20	(010)	54	(070)
21	(323)	55	(058)
22	(513)	56	(620)
23	(534)	57	(513)
24	(019)	58	(534)
25	(208)	59	(707)
26	(843)	60	(208)
27	(010)	61	(513)
28	(810)	62	(534)
29	(010)	63	(707)
30	(323)	64	(208)
31	(513)	65	(070)
32	(534)	66	(900)
33	(019)	67	(843)
34	(208)	68	(800)

↓ 199.0 mm ↔ 199.0 mm

● No. 003



52 min			
1	(005)	13	(005)
2	(620)	14	(620)
3	(509)	15	(807)
4	(209)	16	(005)
5	(509)	17	(620)
6	(019)	18	(807)
7	(509)	19	(005)
8	(209)	20	(620)
9	(005)	21	(807)
10	(817)	22	(005)
11	(070)	23	(406)
12	(086)		

↓ 193.8 mm ↔ 348.8 mm

Embroidery Pattern Color Change Table
 Tableau de changement des couleurs des motifs de broderie
 Tabella dei cambi colore dei ricami
 Tabela de alteração de cor de padrões de bordado

Stickdesign-Farbtabelle
 Kleurenvorgorde voor de borduurpatronen
 Tabla de cambio de color para patrones de bordado
 Таблицы цветов нитей для вышивок

● No. 006



102 min			
1	(070)	30	(607)
2	(399)	31	(804)
3	(517)	32	(704)
4	(513)	33	(214)
5	(509)	34	(399)
6	(804)	35	(517)
7	(399)	36	(804)
8	(517)	37	(613)
9	(804)	38	(070)
10	(613)	39	(607)
11	(070)	40	(804)
12	(607)	41	(704)
13	(804)	42	(214)
14	(704)	43	(399)
15	(214)	44	(214)
16	(399)	45	(517)
17	(517)	46	(070)
18	(804)	47	(607)
19	(613)	48	(214)
20	(070)	49	(399)
21	(607)	50	(214)
22	(804)	51	(517)
23	(704)	52	(070)
24	(214)	53	(607)
25	(399)	54	(214)
26	(517)	55	(517)
27	(804)	56	(804)
28	(613)	57	(517)
29	(070)	58	(804)

↓ 199.9 mm ↔ 299.8 mm

No. 007



56 min			
1	(348)	5	(339)
2	(869)	6	(348)
3	(019)	7	(019)
4	(348)	8	(869)
9	(323)	13	(323)
10	(348)	14	(348)
11	(019)	15	(869)
12	(869)		

↓ 174.4 mm ↔ 345.1 mm

● No. 008



46 min			
1	(323)	15	(807)
2	(328)	16	(070)
3	(517)	17	(405)
4	(513)	18	(513)
5	(070)	19	(209)
6	(328)	20	(328)
7	(206)	21	(513)
8	(807)	22	(328)
9	(405)	23	(206)
10	(209)	24	(807)
11	(807)	25	(405)
12	(030)	26	(070)
13	(209)	27	(030)
14	(206)		

↓ 192.6 mm ↔ 348.0 mm

● No. 009



12 min	
1	(405)

↓ 194.6 mm
↔ 325.0 mm

No. 010



47 min	
1	(612)
2	(405)
3	(542)
4	(001)
5	(019)
6	(405)
7	(542)
8	(405)
9	(019)
10	(001)
11	(070)

↓ 153.0 mm ↔ 153.5 mm

No. 011



41 min	
1	(515)
2	(509)
3	(808)
4	(007)
5	(017)
6	(019)
7	(812)
8	(126)
9	(515)
10	(509)
11	(808)
12	(007)
13	(017)
14	(019)
15	(812)
16	(126)
17	(019)
18	(007)
19	(812)
20	(001)
21	(126)
22	(900)
23	(515)
24	(900)

↓ 121.2 mm ↔ 125.6 mm

No. 012



20 min	
1	(399)
2	(900)
3	(205)
4	(612)
5	(405)
6	(209)
7	(019)
8	(085)
9	(509)
10	(807)

↓ 93.3 mm
↔ 93.5 mm

No. 013



20 min

- 1 (348)
- 2 (209)
- 3 (323)
- 4 (209)
- 5 (206)
- 6 (348)
- 7 (323)
- 8 (209)

↓ 95.3 mm
↔ 175.3 mm

No. 018



15 min

- | | |
|---------|----------|
| 1 (209) | 6 (339) |
| 2 (206) | 7 (323) |
| 3 (209) | 8 (001) |
| 4 (900) | 9 (843) |
| 5 (206) | 10 (900) |

↓ 55.2 mm ↔ 118.9 mm

No. 019



3 min

- 1 (328)

↓ 58.1 mm
↔ 46.8 mm

No. 014



26 min

- | | | | |
|---------|---------|----------|----------|
| 1 (348) | 5 (209) | 9 (348) | 13 (209) |
| 2 (209) | 6 (348) | 10 (209) | |
| 3 (323) | 7 (323) | 11 (323) | |
| 4 (206) | 8 (209) | 12 (206) | |

↓ 94.7 mm ↔ 295.7 mm

No. 020



121 min

- | | | |
|----------|----------|----------|
| 1 (005) | 12 (509) | 23 (307) |
| 2 (513) | 13 (800) | 24 (214) |
| 3 (005) | 14 (507) | 25 (005) |
| 4 (307) | 15 (513) | 26 (800) |
| 5 (001) | 16 (509) | 27 (001) |
| 6 (005) | 17 (507) | 28 (800) |
| 7 (019) | 18 (005) | 29 (507) |
| 8 (513) | 19 (513) | 30 (509) |
| 9 (509) | 20 (019) | 31 (019) |
| 10 (307) | 21 (509) | 32 (900) |
| 11 (513) | 22 (507) | |

↓ 195.5 mm ↔ 345.6 mm

No. 015

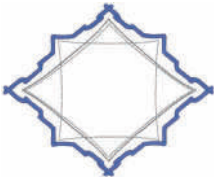

4 min

- 1 (005)
- 2 (817)
- 3 (607)

↓ 77.3 mm
↔ 95.1 mm

★ No. 016



14 min

- | | |
|---------|---------|
| 1 (800) | 5 (348) |
| 2 (800) | 6 (058) |
| 3 (800) | 7 (399) |
| 4 (800) | 8 (328) |

↓ 82.5 mm ↔ 81.3 mm

No. 021



34 min

- | | | | |
|---------|----------|----------|----------|
| 1 (307) | 7 (800) | 13 (800) | 19 (800) |
| 2 (509) | 8 (001) | 14 (307) | 20 (507) |
| 3 (507) | 9 (005) | 15 (005) | 21 (001) |
| 4 (513) | 10 (399) | 16 (214) | 22 (415) |
| 5 (509) | 11 (513) | 17 (509) | 23 (214) |
| 6 (507) | 12 (509) | 18 (001) | |

↓ 54.2 mm ↔ 293.0 mm

No. 017



44 min

- | | | | |
|----------|----------|----------|----------|
| 1 (202) | 11 (019) | 21 (513) | 31 (513) |
| 2 (019) | 12 (202) | 22 (507) | 32 (507) |
| 3 (513) | 13 (126) | 23 (019) | 33 (613) |
| 4 (507) | 14 (030) | 24 (202) | 34 (086) |
| 5 (086) | 15 (086) | 25 (613) | 35 (030) |
| 6 (019) | 16 (202) | 26 (086) | 36 (405) |
| 7 (613) | 17 (001) | 27 (202) | 37 (513) |
| 8 (001) | 18 (513) | 28 (001) | 38 (202) |
| 9 (126) | 19 (507) | 29 (126) | |
| 10 (405) | 20 (405) | 30 (019) | |

↓ 55.7 mm ↔ 292.6 mm

No. 022



31 min

- | | | | |
|---------|---------|----------|----------|
| 1 (208) | 5 (339) | 9 (005) | 13 (323) |
| 2 (001) | 6 (005) | 10 (900) | |
| 3 (206) | 7 (900) | 11 (010) | |
| 4 (900) | 8 (339) | 12 (058) | |

↓ 57.0 mm ↔ 289.3 mm

No. 023 **48 min**

1	■ (900)
2	■ (030)

↓ 193.9 mm
 ⇔ 230.4 mm

No. 024 **47 min**

1	■ (900)
2	■ (030)

↓ 196.2 mm
 ⇔ 225.7 mm

No. 025 **20 min**

1	■ (900)
2	■ (030)

↓ 144.9 mm
 ⇔ 125.7 mm

No. 026 **15 min**

1	■ (900)
2	■ (030)

↓ 108.4 mm
 ⇔ 102.1 mm

No. 027 **15 min**

1	■ (900)
2	■ (030)

↓ 95.0 mm
 ⇔ 109.3 mm

No. 028 **21 min**

1	■ (900)
2	■ (030)

↓ 111.6 mm
 ⇔ 143.6 mm

No. 029 **8 min**

1	■ (900)
2	■ (030)

↓ 97.7 mm
 ⇔ 85.6 mm

No. 030 **13 min**

1	■ (900)
2	■ (030)

↓ 96.7 mm
 ⇔ 93.5 mm

No. 031 **10 min**

1	■ (900)
2	■ (030)

↓ 97.7 mm
 ⇔ 73.4 mm

No. 032 **32 min**

1	■ (807)
2	■ (086)
3	■ (612)
4	■ (607)
5	■ (019)
6	■ (405)
7	■ (534)
8	■ (509)
9	■ (206)
10	■ (126)
11	■ (807)

↓ 160.4 mm
 ⇔ 126.0 mm

No.023 Ryuu:Dragon/Drachen/Dragon/Draak/Dragone/Dragón/Dragão/Дракон
 No.024 Zen:Zen/Zen/Zen/Zen/Zen/Zen/Дзен
 No.025 Takumi:Artisan/Kunsthändler/Artisan/Kunstenaar/Artigiano/Artesanal/Artesão/Ремесленник
 No.026 Huku:Good fortune/Glück/Bonne chance/Geluk/Buona fortuna/Buena suerte/Boa sorte/Счастье
 No.027 Chi:Wisdom/Weisheit/Sagesse/Wijsheid/Saggezza/Sabiduría/Sabedoria/Sabedoria/Мудрость
 No.028 Samurai:Samurai/Samurai/Samurai/Samurai/Samurai/Samurai/Самурай
 No.029 Bi:Beauty/Schönheit/Beauté/Schoonheid/Bellezza/Belleza/Beleza/Красота
 No.030 Ai:Love/Liebe/Amour/Liefde/Amore/Amor/Amor/Любовь
 No.031 Heiwa:Peace/Frieden/Paix/Vrede/Pace/Paz/Paz/Мир
 No.032 Yume:Dream/Traum/Rêve/Droom/Sogno/Sueño/Sonho/Мечта

Patterns No.023 – No.032, are designed by Taisen Okamoto.
 Muster Nr. 023 – Nr. 032 wurden von Taisen Okamoto entworfen.
 Les motifs n° 023 à 032 ont été conçus par Taisen Okamoto.
 De patronen 023-032 zijn ontworpen door Taisen Okamoto.
 I ricami dal N° 023 al N° 032 sono stati realizzati da Taisen Okamoto.
 Los patrones N.º 023 – N.º 032, están diseñados por Taisen Okamoto.
 Os padrões N.º 023 a N.º 032 foram desenhados por Taisen Okamoto.
 Автор дизайнов № 023–032 — Тайсен Окамото.

No. 033 **31 min**

1	■ (420)	6	■ (420)	11	■ (399)	16	■ (399)
2	■ (079)	7	■ (079)	12	■ (420)	17	■ (420)
3	■ (017)	8	■ (420)	13	■ (079)	18	■ (001)
4	■ (027)	9	■ (027)	14	■ (027)	19	■ (027)
5	■ (399)	10	■ (017)	15	■ (017)	20	■ (420)

↓ 65.3 mm ⇔ 290.5 mm

No. 034 **27 min**

1	■ (017)	7	■ (420)	13	■ (027)	19	■ (420)
2	■ (420)	8	■ (027)	14	■ (079)	20	■ (017)
3	■ (027)	9	■ (079)	15	■ (399)	21	■ (420)
4	■ (079)	10	■ (399)	16	■ (420)	22	■ (079)
5	■ (399)	11	■ (017)	17	■ (001)	23	■ (027)
6	■ (017)	12	■ (420)	18	■ (027)	24	■ (399)

↓ 99.4 mm ⇔ 174.0 mm



No. 035

18 min

- 1 (607)
- 2 (019)
- 3 (810)
- 4 (070)

↓ 81.7 mm
↔ 279.8 mm



No. 036

9 min

- 1 (607)
- 2 (019)
- 3 (810)
- 4 (070)

↓ 90.6 mm
↔ 92.8 mm



No. 037

132 min

- 1 (509)
- 2 (513)
- 3 (515)
- 4 (027)
- 5 (001)
- 6 (017)
- 7 (542)
- 8 (206)
- 9 (208)
- 10 (509)
- 11 (513)
- 12 (515)
- 13 (027)
- 14 (001)
- 15 (017)
- 16 (542)
- 17 (206)
- 18 (208)

↓ 189.7 mm
↔ 348.9 mm



No. 038

59 min

- 1 (017)
- 2 (804)
- 3 (502)
- 4 (810)
- 5 (001)
- 6 (607)
- 7 (804)
- 8 (019)
- 9 (085)
- 10 (001)

↓ 182.4 mm
↔ 193.4 mm



No. 039

34 min

- 1 (509)
- 2 (017)
- 3 (001)
- 4 (202)
- 5 (079)
- 6 (804)
- 7 (807)
- 8 (027)
- 9 (509)
- 10 (001)
- 11 (202)
- 12 (027)
- 13 (502)
- 14 (017)
- 15 (079)
- 16 (807)
- 17 (027)

↓ 171.5 mm
↔ 125.9 mm



No. 040

119 min

- 1 (348)
- 2 (399)
- 3 (328)
- 4 (001)
- 5 (017)
- 6 (406)
- 7 (328)
- 8 (001)
- 9 (017)
- 10 (019)
- 11 (406)
- 12 (328)
- 13 (001)
- 14 (017)
- 15 (019)
- 16 (406)
- 17 (328)
- 18 (001)
- 19 (017)
- 20 (019)
- 21 (406)
- 22 (328)

↓ 175.1 mm
↔ 348.4 mm



No. 041

49 min

- 1 (800)
- 2 (507)
- 3 (001)
- 4 (620)
- 5 (206)
- 6 (405)
- 7 (800)
- 8 (620)

↓ 193.2 mm
↔ 188.8 mm



No. 042

23 min

- 1 (001)
- 2 (030)
- 3 (019)
- 4 (509)
- 5 (800)
- 6 (509)
- 7 (030)

↓ 67.0 mm
↔ 176.0 mm



No. 043

57 min

- 1 (843)
- 2 (005)
- 3 (843)
- 4 (399)
- 5 (005)
- 6 (804)
- 7 (843)
- 8 (804)
- 9 (399)
- 10 (804)
- 11 (005)
- 12 (843)
- 13 (399)
- 14 (804)
- 15 (005)
- 16 (843)
- 17 (810)

↓ 193.0 mm
↔ 340.5 mm



● No. 044

50 min	
1	(328)
2	(323)
3	(124)
4	(542)
5	(810)
6	(086)
7	(804)
8	(607)
9	(206)
10	(328)

↓ 178.9 mm
 ↔ 341.9 mm



★ No. 048

116 min					
1	--->>(517)	9	(517)	17	(010)
2	(406)	10	(704)	18	(517)
3	(517)	11	(001)	19	(001)
4	(704)	12	(337)	20	(406)
5	(001)	13	(058)	21	(001)
6	(337)	14	-----(517)	22	(406)
7	(058)	15	~~~~~(517)	23	(001)
8	(406)	16	(517)	24	(406)

↓ 163.3 mm ↔ 350.1 mm

● No. 045



92 min			
1	(509)	21	(515)
2	(810)	22	(534)
3	(515)	23	(509)
4	(534)	24	(202)
5	(085)	25	(085)
6	(086)	26	(107)
7	(810)	27	(085)
8	(612)	28	(086)
9	(202)	29	(810)
10	(534)	30	(509)
11	(509)	31	(810)
12	(614)	32	(534)
13	(107)	33	(107)
14	(509)	34	(612)
15	(534)	35	(614)
16	(085)	36	(086)
17	(810)	37	(202)
18	(086)	38	(612)
19	(612)	39	(107)
20	(107)		

↓ 195.4 mm ↔ 331.7 mm

No. 049



14 min					
1	(206)	5	(206)	9	(206)
2	(086)	6	(001)	10	(807)
3	(019)	7	(085)		
4	(017)	8	(086)		

↓ 48.2 mm ↔ 156.8 mm

No. 046



38 min			
1	(509)	10	(085)
2	(515)	11	(614)
3	(810)	12	(612)
4	(086)	13	(107)
5	(810)	14	(202)
6	(085)	15	(107)
7	(612)	16	(086)
8	(515)	17	(509)
9	(534)		

↓ 132.6 mm ↔ 125.8 mm

No. 050



24 min					
1	(001)	6	(209)	11	(513)
2	(205)	7	(513)	12	(205)
3	(800)	8	(001)	13	(019)
4	(019)	9	(800)		
5	(405)	10	(900)		

↓ 65.1 mm ↔ 153.9 mm

No. 047



53 min							
1	(509)	9	(614)	17	(807)	25	(807)
2	(810)	10	(612)	18	(534)	26	(085)
3	(515)	11	(202)	19	(509)	27	(612)
4	(534)	12	(085)	20	(515)	28	(614)
5	(086)	13	(807)	21	(534)	29	(202)
6	(085)	14	(612)	22	(202)	30	(807)
7	(534)	15	(085)	23	(807)		
8	(509)	16	(086)	24	(614)		

↓ 89.6 mm ↔ 291.8 mm

No. 51



10 min					
1	(348)	5	(086)	9	(323)
2	(206)	6	(017)	10	(001)
3	(812)	7	(085)		
4	(206)	8	(513)		

↓ 35.3 mm ↔ 95.6 mm

- "Variety" Designs
- Motifs divers
- Ricami "originali"
- Desenhos "diversos"

- „Variety“-Stickmuster
- Diverse thema borduurpatronen
- Diseños de temas diversos
- Дизайны "Разные"



No. 001

6 min	
1	(208)
2	(323)
3	(405)
4	(420)
5	(030)
6	(107)

↓ 48.6 mm
↔ 63.1 mm

No. 008

9 min	
1	(005)
2	(001)
3	(205)
4	(017)
5	(704)
6	(900)

↓ 48.4 mm
↔ 64.2 mm

No. 013

11 min	
1	(614)
2	(900)
3	(209)
4	(800)
5	(030)

↓ 36.4 mm
↔ 93.8 mm

No. 002

4 min	
1	(800)
2	(001)

↓ 37.7 mm
↔ 59.8 mm

No. 009

15 min	
1	(027)
2	(612)
3	(070)
4	(502)
5	(019)
6	(085)
7	(206)
8	(086)
9	(001)
10	(070)

↓ 52.4 mm
↔ 63.0 mm

No. 014

14 min	
1	(406)
2	(507)
3	(513)
4	(205)
5	(513)
6	(612)
7	(019)
8	(001)
9	(086)
10	(328)
11	(800)
12	(205)

↓ 56.1 mm
↔ 71.7 mm

No. 003

8 min	
1	(420)
2	(800)

↓ 94.8 mm
↔ 94.7 mm

No. 010

14 min	
1	(214)
2	(323)
3	(339)
4	(030)
5	(515)
6	(513)
7	(209)
8	(208)
9	(612)
10	(620)
11	(339)

↓ 52.8 mm
↔ 69.3 mm

No. 015

9 min	
1	(001)
2	(017)
3	(206)
4	(807)
5	(612)
6	(515)

↓ 54.5 mm
↔ 76.3 mm

No. 004

2 min	
1	(339)
2	(058)

↓ 26.6 mm
↔ 11.4 mm

No. 011

10 min	
1	(010)
2	(027)
3	(001)
4	(620)
5	(205)
6	(900)
7	(030)
8	(339)
9	(405)
10	(030)

↓ 60.6 mm
↔ 68.2 mm

No. 016

34 min	
1	(205)
2	(206)
3	(107)
4	(030)
5	(800)
6	(307)
7	(843)
8	(001)
9	(399)
10	(005)
11	(323)
12	(058)
13	(205)
14	(206)

↓ 124.6 mm
↔ 76.3 mm

No. 005

1 min	
1	(208)
2	(058)
3	(339)

↓ 28.9 mm
↔ 15.7 mm

No. 006

5 min	
1	(208)
2	(001)
3	(030)
4	(058)

↓ 41.6 mm
↔ 38.1 mm

No. 007

7 min	
1	(005)
2	(323)
3	(214)
4	(900)

↓ 42.7 mm
↔ 58.4 mm

No. 012

10 min	
1	(208)
2	(515)
3	(513)
4	(058)
5	(209)
6	(339)
7	(030)

↓ 50.1 mm
↔ 73.5 mm

No. 017

13 min	
1	(348)
2	(323)
3	(005)
4	(800)
5	(614)
6	(058)
7	(515)
8	(420)
9	(707)

↓ 53.0 mm
↔ 59.4 mm

No. 018



8 min	
1	(205)
2	(208)
3	(030)
4	(019)
5	(415)
6	(513)
7	(509)
8	(001)
9	(704)

↓ 51.3 mm
 ↔ 61.9 mm

No. 019



11 min	
1	(030)
2	(208)
3	(900)
4	(208)

↓ 52.5 mm
 ↔ 59.5 mm

No. 020



11 min	
1	(001)
2	(307)
3	(348)
4	(005)
5	(704)
6	(019)
7	(030)
8	(614)
9	(214)
10	(900)
11	(001)

↓ 48.5 mm
 ↔ 63.5 mm

No. 021



11 min	
1	(001)
2	(208)
3	(030)
4	(607)
5	(513)
6	(420)
7	(900)

↓ 56.8 mm
 ↔ 50.0 mm

No. 022



11 min	
1	(323)
2	(005)
3	(205)
4	(513)
5	(515)
6	(107)
7	(209)
8	(001)
9	(030)
10	(900)

↓ 45.0 mm
 ↔ 57.2 mm

No. 023



7 min	
1	(405)
2	(019)
3	(027)
4	(209)
5	(030)
6	(007)
7	(005)

↓ 55.4 mm
 ↔ 57.8 mm

No. 024



9 min	
1	(205)
2	(513)
3	(019)
4	(070)
5	(810)
6	(001)
7	(017)
8	(800)
9	(620)
10	(070)

↓ 50.7 mm
 ↔ 71.7 mm

No. 025



15 min	
1	(206)
2	(807)
3	(007)
4	(005)
5	(001)
6	(807)
7	(405)
8	(807)
9	(206)
10	(900)
11	(214)

↓ 57.8 mm
 ↔ 58.6 mm

No. 026

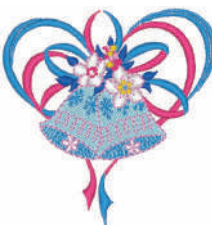

14 min	
1	(086)
2	(017)
3	(019)
4	(405)
5	(001)
6	(810)
7	(086)
8	(206)

↓ 76.3 mm
 ↔ 73.8 mm

No. 027



8 min	
1	(405)
2	(019)
3	(001)
4	(086)
5	(206)
6	(810)
7	(017)

↓ 23.0 mm
 ↔ 95.2 mm

No. 028



5 min	
1	(017)
2	(124)
3	(086)
4	(085)
5	(019)

↓ 62.0 mm
 ↔ 46.7 mm

No. 029



24 min	
1	(513)
2	(206)
3	(001)
4	(810)
5	(017)
6	(085)
7	(086)
8	(017)
9	(086)
10	(405)
11	(085)

↓ 94.4 mm ↔ 124.2 mm

No. 030



7 min	
1	(019)
2	(509)
3	(085)
4	(086)
5	(900)
6	(001)
7	(704)

↓ 51.2 mm
 ↔ 80.6 mm

No. 031



5 min	
1	(707)
2	(070)
3	(509)
4	(515)
5	(807)

↓ 43.0 mm
 ↔ 93.1 mm

No. 032



4 min	
1	(085)
2	(017)
3	(019)
4	(086)

↓ 45.0 mm
 ↔ 16.2 mm

No. 033



10 min	
1	(208)
2	(420)
3	(415)
4	(205)
5	(001)

↓ 77.5 mm
 ↔ 85.3 mm

No. 034



12 min	
1	(001)
2	(704)
3	(707)
4	(019)
5	(399)
6	(206)
7	(323)
8	(058)
9	(339)

↓ 73.7 mm
 ↔ 81.4 mm

No. 035



6 min

1	(019)
2	(513)
3	(509)
4	(507)
5	(513)

↓ 45.4 mm
↔ 46.2 mm

No. 036



4 min

1	(001)
2	(507)
3	(086)

↓ 35.8 mm
↔ 49.5 mm

No. 037



3 min

1	(202)
2	(001)
3	(507)

↓ 35.4 mm
↔ 21.7 mm

No. 038



25 min

1	(812)
2	(214)
3	(030)
4	(337)
5	(107)
6	(507)

↓ 58.8 mm
↔ 65.1 mm

No. 039



7 min

1	(010)
2	(513)
3	(515)
4	(800)
5	(513)
6	(206)
7	(079)
8	(086)
9	(214)
10	(337)

↓ 32.4 mm
↔ 49.5 mm

No. 040



14 min

1	(001)	7	(513)
2	(017)	8	(086)
3	(019)	9	(214)
4	(214)	10	(800)
5	(205)	11	(339)
6	(058)		

↓ 49.7 mm ↔ 87.7 mm

No. 041



16 min

1	(205)	7	(001)
2	(513)	8	(339)
3	(800)	9	(399)
4	(086)	10	(707)
5	(405)	11	(001)
6	(607)		

↓ 77.2 mm ↔ 70.7 mm

No. 042



4 min

1	(900)
---	-------

↓ 41.4 mm
↔ 69.7 mm

No. 043



9 min

1	(086)	4	(017)
2	(079)	5	(019)
3	(027)	6	(420)

↓ 49.3 mm ↔ 63.3 mm

No. 044



14 min

1	(001)
2	(205)
3	(328)
4	(323)
5	(534)
6	(513)
7	(517)
8	(086)

↓ 65.0 mm
↔ 52.1 mm

No. 045



5 min

1	(519)
---	-------

↓ 28.2 mm
↔ 137.8 mm

No. 046



11 min

1	(843)
2	(348)
3	(079)
4	(323)
5	(337)
6	(513)
7	(058)

↓ 60.1 mm
↔ 44.4 mm

No. 047



12 min

1	(214)
2	(328)
3	(323)
4	(030)
5	(843)
6	(339)

↓ 74.7 mm
↔ 50.0 mm

No. 048



16 min

1	(001)	6	(513)
2	(339)	7	(405)
3	(612)	8	(085)
4	(804)	9	(030)
5	(800)	10	(205)

↓ 50.4 mm ↔ 82.7 mm

No. 049



17 min

1	(001)
2	(019)
3	(205)
4	(209)
5	(085)
6	(030)
7	(900)
8	(405)
9	(339)

↓ 76.5 mm
↔ 69.9 mm

- Common Design Patterns
- Motifs courants
- Ricami di uso comune
- Padrões comuns de desenhos

- Allgemeine Stickdesigns
- Test- en oefenborduurpatronen
- Diseños comunes
- Стандартные дизайны



No. 001



9 min	
1	(513)
2	(515)
3	(807)
4	(800)
5	(620)
6	(607)
7	(613)
8	(001)
9	(206)

↓ 29.5 mm
 ↔ 56.6 mm

No. 002



6 min	
1	(323)
2	(507)
3	(513)
4	(205)
5	(209)
6	(800)
7	(085)
8	(612)
9	(420)
10	(900)

↓ 30.0 mm ↔ 96.1 mm

No. 003



6 min	
1	(323)
2	(323)
3	(323)
4	(323)
5	(405)
6	(515)
7	(030)
8	(214)

↓ 94.3 mm
 ↔ 66.3 mm

For tutorial practice
 Für Lernübungen
 Pour une pratique d'apprentissage
 Als oefening
 Da utilizzare per il tutorial
 Para práctica tutorial
 Para a prática tutorial
 Для практического обучения

For checking the thread tension
 Zur Überprüfung der Fadenspannung
 Pour contrôler la tension du fil
 Om de draadspanning te controleren
 Per controllare la tensione del filo
 Para comprobar la tensión del hilo
 Para verificar a tensão da linha
 Для проверки натяжения нити

For tutorial practice of embroidering appliqué
 Für Lernprogramm-Übungen von Stickapplikationen
 Pour une pratique d'apprentissage de broderie d'un motif d'appliqué
 Voor het oefenen van applicaties aan de hand van de lesgids
 Per la pratica guidata del ricamo dell'appliqué
 Para la práctica del tutorial de bordado de adornos
 Para a prática tutorial de apliques de bordado
 В целях обучения вышиванию аппликаций

- ◆ Utility embroidery patterns / Large buttonhole patterns
- ◆ Motifs de broderie courants/ Grands motifs de boutonnieres
- ◆ Ricami utili/Ricami per asole grandi
- ◆ Padrões de bordado úteis/ Padrões de casas para botões grandes

- ◆ Nutzstich-Stickmuster/ Muster für große Knopflöcher
- ◆ Borduursteken/ Grote knoopsgatpatronen
- ◆ Patrones de bordado de utilidad/ Patrones para ojales de gran tamaño
- ◆ Основные строчки для вышивания/ Большие петли для вышивания



- Utility embroidery patterns
- Motifs de broderie courants
- Ricami utili
- Padrões de bordado úteis

- Nutzstich-Stickmuster
- Borduursteken
- Patrones de bordado de utilidad
- Основные строчки для вышивания



No. 001



1 min	
1	(900)

↓ 31.5 mm
 ↔ 0.1 mm

No. 004



1 min	
1	(900)

↓ 16.8 mm
 ↔ 7.0 mm

No. 007



1 min	
1	(900)

↓ 19.2 mm
 ↔ 7.0 mm

No. 010



1 min	
1	(900)

↓ 15.8 mm
 ↔ 9.2 mm

No. 002



1 min	
1	(900)

↓ 30.4 mm
 ↔ 3.0 mm

No. 005



1 min	
1	(900)

↓ 38.0 mm
 ↔ 3.0 mm

No. 008



1 min	
1	(900)

↓ 11.0 mm
 ↔ 7.0 mm

No. 011



1 min	
1	(900)

↓ 19.7 mm
 ↔ 9.0 mm

No. 003



1 min	
1	(900)

↓ 16.5 mm
 ↔ 7.0 mm

No. 006



1 min	
1	(900)

↓ 8.4 mm
 ↔ 7.0 mm

No. 009



1 min	
1	(900)





















↓ 19.5 mm
 ↔ 12.0 mm

No. 012



























1 min	
1	(900)

↓ 10.8 mm
 ↔ 12.0 mm

<p>No. 013</p>  <div style="border: 1px solid black; padding: 2px; width: fit-content;"> <p style="text-align: center; margin: 0;">1 min</p> <p style="text-align: center; margin: 0;">1 ■■■ (900)</p> <p style="text-align: center; margin: 0;">↓ 11.4 mm</p> <p style="text-align: center; margin: 0;">↔ 11.9 mm</p> </div>	<p>No. 021</p>  <div style="border: 1px solid black; padding: 2px; width: fit-content;"> <p style="text-align: center; margin: 0;">1 min</p> <p style="text-align: center; margin: 0;">1 ■■■ (900)</p> <p style="text-align: center; margin: 0;">↓ 33.0 mm</p> <p style="text-align: center; margin: 0;">↔ 12.0 mm</p> </div>	<p>No. 029</p>  <div style="border: 1px solid black; padding: 2px; width: fit-content;"> <p style="text-align: center; margin: 0;">1 min</p> <p style="text-align: center; margin: 0;">1 ■■■ (900)</p> <p style="text-align: center; margin: 0;">↓ 29.0 mm</p> <p style="text-align: center; margin: 0;">↔ 14.9 mm</p> </div>	<p>No. 037</p>  <div style="border: 1px solid black; padding: 2px; width: fit-content;"> <p style="text-align: center; margin: 0;">1 min</p> <p style="text-align: center; margin: 0;">1 ■■■ (900)</p> <p style="text-align: center; margin: 0;">↓ 48.1 mm</p> <p style="text-align: center; margin: 0;">↔ 8.1 mm</p> </div>
<p>No. 014</p>  <div style="border: 1px solid black; padding: 2px; width: fit-content;"> <p style="text-align: center; margin: 0;">1 min</p> <p style="text-align: center; margin: 0;">1 ■■■ (900)</p> <p style="text-align: center; margin: 0;">↓ 13.6 mm</p> <p style="text-align: center; margin: 0;">↔ 13.6 mm</p> </div>	<p>No. 022</p>  <div style="border: 1px solid black; padding: 2px; width: fit-content;"> <p style="text-align: center; margin: 0;">1 min</p> <p style="text-align: center; margin: 0;">1 ■■■ (900)</p> <p style="text-align: center; margin: 0;">↓ 16.0 mm</p> <p style="text-align: center; margin: 0;">↔ 12.4 mm</p> </div>	<p>No. 030</p>  <div style="border: 1px solid black; padding: 2px; width: fit-content;"> <p style="text-align: center; margin: 0;">1 min</p> <p style="text-align: center; margin: 0;">1 ■■■ (900)</p> <p style="text-align: center; margin: 0;">↓ 15.7 mm</p> <p style="text-align: center; margin: 0;">↔ 11.2 mm</p> </div>	<p>No. 038</p>  <div style="border: 1px solid black; padding: 2px; width: fit-content;"> <p style="text-align: center; margin: 0;">1 min</p> <p style="text-align: center; margin: 0;">1 ■■■ (900)</p> <p style="text-align: center; margin: 0;">↓ 82.3 mm</p> <p style="text-align: center; margin: 0;">↔ 19.4 mm</p> </div>
<p>No. 015</p>  <div style="border: 1px solid black; padding: 2px; width: fit-content;"> <p style="text-align: center; margin: 0;">1 min</p> <p style="text-align: center; margin: 0;">1 ■■■ (900)</p> <p style="text-align: center; margin: 0;">↓ 14.4 mm</p> <p style="text-align: center; margin: 0;">↔ 7.0 mm</p> </div>	<p>No. 023</p>  <div style="border: 1px solid black; padding: 2px; width: fit-content;"> <p style="text-align: center; margin: 0;">1 min</p> <p style="text-align: center; margin: 0;">1 ■■■ (900)</p> <p style="text-align: center; margin: 0;">↓ 15.4 mm</p> <p style="text-align: center; margin: 0;">↔ 12.0 mm</p> </div>	<p>No. 031</p>  <div style="border: 1px solid black; padding: 2px; width: fit-content;"> <p style="text-align: center; margin: 0;">1 min</p> <p style="text-align: center; margin: 0;">1 ■■■ (900)</p> <p style="text-align: center; margin: 0;">↓ 19.1 mm</p> <p style="text-align: center; margin: 0;">↔ 11.4 mm</p> </div>	<p>No. 039</p>  <div style="border: 1px solid black; padding: 2px; width: fit-content;"> <p style="text-align: center; margin: 0;">1 min</p> <p style="text-align: center; margin: 0;">1 ■■■ (900)</p> <p style="text-align: center; margin: 0;">↓ 28.0 mm</p> <p style="text-align: center; margin: 0;">↔ 11.9 mm</p> </div>
<p>No. 016</p>  <div style="border: 1px solid black; padding: 2px; width: fit-content;"> <p style="text-align: center; margin: 0;">1 min</p> <p style="text-align: center; margin: 0;">1 ■■■ (900)</p> <p style="text-align: center; margin: 0;">↓ 38.0 mm</p> <p style="text-align: center; margin: 0;">↔ 8.0 mm</p> </div>	<p>No. 024</p>  <div style="border: 1px solid black; padding: 2px; width: fit-content;"> <p style="text-align: center; margin: 0;">1 min</p> <p style="text-align: center; margin: 0;">1 ■■■ (900)</p> <p style="text-align: center; margin: 0;">↓ 20.8 mm</p> <p style="text-align: center; margin: 0;">↔ 12.2 mm</p> </div>	<p>No. 032</p>  <div style="border: 1px solid black; padding: 2px; width: fit-content;"> <p style="text-align: center; margin: 0;">1 min</p> <p style="text-align: center; margin: 0;">1 ■■■ (900)</p> <p style="text-align: center; margin: 0;">↓ 13.0 mm</p> <p style="text-align: center; margin: 0;">↔ 7.9 mm</p> </div>	<p>No. 040</p>  <div style="border: 1px solid black; padding: 2px; width: fit-content;"> <p style="text-align: center; margin: 0;">1 min</p> <p style="text-align: center; margin: 0;">1 ■■■ (900)</p> <p style="text-align: center; margin: 0;">↓ 16.8 mm</p> <p style="text-align: center; margin: 0;">↔ 12.0 mm</p> </div>
<p>No. 017</p>  <div style="border: 1px solid black; padding: 2px; width: fit-content;"> <p style="text-align: center; margin: 0;">1 min</p> <p style="text-align: center; margin: 0;">1 ■■■ (900)</p> <p style="text-align: center; margin: 0;">↓ 12.6 mm</p> <p style="text-align: center; margin: 0;">↔ 8.4 mm</p> </div>	<p>No. 025</p>  <div style="border: 1px solid black; padding: 2px; width: fit-content;"> <p style="text-align: center; margin: 0;">1 min</p> <p style="text-align: center; margin: 0;">1 ■■■ (900)</p> <p style="text-align: center; margin: 0;">↓ 42.0 mm</p> <p style="text-align: center; margin: 0;">↔ 13.2 mm</p> </div>	<p>No. 033</p>  <div style="border: 1px solid black; padding: 2px; width: fit-content;"> <p style="text-align: center; margin: 0;">1 min</p> <p style="text-align: center; margin: 0;">1 ■■■ (900)</p> <p style="text-align: center; margin: 0;">↓ 21.4 mm</p> <p style="text-align: center; margin: 0;">↔ 8.0 mm</p> </div>	<p>No. 041</p>  <div style="border: 1px solid black; padding: 2px; width: fit-content;"> <p style="text-align: center; margin: 0;">1 min</p> <p style="text-align: center; margin: 0;">1 ■■■ (900)</p> <p style="text-align: center; margin: 0;">↓ 19.2 mm</p> <p style="text-align: center; margin: 0;">↔ 12.0 mm</p> </div>
<p>No. 018</p>  <div style="border: 1px solid black; padding: 2px; width: fit-content;"> <p style="text-align: center; margin: 0;">1 min</p> <p style="text-align: center; margin: 0;">1 ■■■ (900)</p> <p style="text-align: center; margin: 0;">↓ 10.8 mm</p> <p style="text-align: center; margin: 0;">↔ 8.4 mm</p> </div>	<p>No. 026</p>  <div style="border: 1px solid black; padding: 2px; width: fit-content;"> <p style="text-align: center; margin: 0;">1 min</p> <p style="text-align: center; margin: 0;">1 ■■■ (900)</p> <p style="text-align: center; margin: 0;">↓ 16.8 mm</p> <p style="text-align: center; margin: 0;">↔ 10.0 mm</p> </div>	<p>No. 034</p>  <div style="border: 1px solid black; padding: 2px; width: fit-content;"> <p style="text-align: center; margin: 0;">1 min</p> <p style="text-align: center; margin: 0;">1 ■■■ (900)</p> <p style="text-align: center; margin: 0;">↓ 29.7 mm</p> <p style="text-align: center; margin: 0;">↔ 11.0 mm</p> </div>	<p>No. 042</p>  <div style="border: 1px solid black; padding: 2px; width: fit-content;"> <p style="text-align: center; margin: 0;">1 min</p> <p style="text-align: center; margin: 0;">1 ■■■ (900)</p> <p style="text-align: center; margin: 0;">↓ 29.2 mm</p> <p style="text-align: center; margin: 0;">↔ 12.0 mm</p> </div>
<p>No. 019</p>  <div style="border: 1px solid black; padding: 2px; width: fit-content;"> <p style="text-align: center; margin: 0;">1 min</p> <p style="text-align: center; margin: 0;">1 ■■■ (900)</p> <p style="text-align: center; margin: 0;">↓ 15.8 mm</p> <p style="text-align: center; margin: 0;">↔ 12.4 mm</p> </div>	<p>No. 027</p>  <div style="border: 1px solid black; padding: 2px; width: fit-content;"> <p style="text-align: center; margin: 0;">1 min</p> <p style="text-align: center; margin: 0;">1 ■■■ (900)</p> <p style="text-align: center; margin: 0;">↓ 8.7 mm</p> <p style="text-align: center; margin: 0;">↔ 8.0 mm</p> </div>	<p>No. 035</p>  <div style="border: 1px solid black; padding: 2px; width: fit-content;"> <p style="text-align: center; margin: 0;">1 min</p> <p style="text-align: center; margin: 0;">1 ■■■ (900)</p> <p style="text-align: center; margin: 0;">↓ 24.1 mm</p> <p style="text-align: center; margin: 0;">↔ 12.0 mm</p> </div>	<p>No. 043</p>  <div style="border: 1px solid black; padding: 2px; width: fit-content;"> <p style="text-align: center; margin: 0;">1 min</p> <p style="text-align: center; margin: 0;">1 ■■■ (900)</p> <p style="text-align: center; margin: 0;">↓ 17.6 mm</p> <p style="text-align: center; margin: 0;">↔ 15.6 mm</p> </div>
<p>No. 020</p>  <div style="border: 1px solid black; padding: 2px; width: fit-content;"> <p style="text-align: center; margin: 0;">1 min</p> <p style="text-align: center; margin: 0;">1 ■■■ (900)</p> <p style="text-align: center; margin: 0;">↓ 16.8 mm</p> <p style="text-align: center; margin: 0;">↔ 7.0 mm</p> </div>	<p>No. 028</p>  <div style="border: 1px solid black; padding: 2px; width: fit-content;"> <p style="text-align: center; margin: 0;">1 min</p> <p style="text-align: center; margin: 0;">1 ■■■ (900)</p> <p style="text-align: center; margin: 0;">↓ 11.4 mm</p> <p style="text-align: center; margin: 0;">↔ 5.0 mm</p> </div>	<p>No. 036</p>  <div style="border: 1px solid black; padding: 2px; width: fit-content;"> <p style="text-align: center; margin: 0;">1 min</p> <p style="text-align: center; margin: 0;">1 ■■■ (900)</p> <p style="text-align: center; margin: 0;">↓ 45.0 mm</p> <p style="text-align: center; margin: 0;">↔ 7.0 mm</p> </div>	<p>No. 044</p>  <div style="border: 1px solid black; padding: 2px; width: fit-content;"> <p style="text-align: center; margin: 0;">1 min</p> <p style="text-align: center; margin: 0;">1 ■■■ (900)</p> <p style="text-align: center; margin: 0;">↓ 17.6 mm</p> <p style="text-align: center; margin: 0;">↔ 9.0 mm</p> </div>

Embroidery Pattern Color Change Table
 Tableau de changement des couleurs des motifs de broderie
 Tabella dei cambi colore dei ricami
 Tabela de alteração de cor de padrões de bordado

Stickdesign-Farbtabelle
 Kleurenvolgeorde voor de borduurpatronen
 Tabla de cambio de color para patrones de bordado
 Таблицы цветов нитей для вышивок

No. 045  1 min 1 ■ (900) ↓ 47.5 mm ⇔ 20.0 mm	No. 053  1 min 1 ■ (900) ↓ 13.0 mm ⇔ 14.6 mm	No. 061  1 min 1 ■ (900) ↓ 33.7 mm ⇔ 40.0 mm	No. 069  1 min 1 ■ (900) ↓ 24.5 mm ⇔ 9.0 mm
No. 046  1 min 1 ■ (900) ↓ 16.4 mm ⇔ 21.8 mm	No. 054  1 min 1 ■ (900) ↓ 14.4 mm ⇔ 11.9 mm	No. 062  1 min 1 ■ (900) ↓ 46.0 mm ⇔ 80.0 mm	No. 070  1 min 1 ■ (900) ↓ 57.0 mm ⇔ 9.0 mm
No. 047  1 min 1 ■ (900) ↓ 15.5 mm ⇔ 14.0 mm	No. 055  1 min 1 ■ (900) ↓ 31.6 mm ⇔ 14.9 mm	No. 063  1 min 1 ■ (900) ↓ 65.3 mm ⇔ 40.3 mm	No. 071  1 min 1 ■ (900) ↓ 32.0 mm ⇔ 10.0 mm
No. 048  1 min 1 ■ (900) ↓ 16.2 mm ⇔ 14.8 mm	No. 056  1 min 1 ■ (900) ↓ 39.2 mm ⇔ 7.0 mm	No. 064  1 min 1 ■ (900) ↓ 77.3 mm ⇔ 19.9 mm	No. 072  1 min 1 ■ (900) ↓ 33.5 mm ⇔ 20.0 mm
No. 049  1 min 1 ■ (900) ↓ 18.1 mm ⇔ 12.7 mm	No. 057  1 min 1 ■ (900) ↓ 41.8 mm ⇔ 9.6 mm	No. 065  1 min 1 ■ (900) ↓ 85.9 mm ⇔ 42.1 mm	No. 073  1 min 1 ■ (900) ↓ 37.5 mm ⇔ 21.0 mm
No. 050  1 min 1 ■ (900) ↓ 25.2 mm ⇔ 15.1 mm	No. 058  1 min 1 ■ (900) ↓ 45.7 mm ⇔ 45.9 mm	No. 066  1 min 1 ■ (900) ↓ 50.0 mm ⇔ 40.0 mm	No. 074  1 min 1 ■ (900) ↓ 36.0 mm ⇔ 20.0 mm
No. 051  1 min 1 ■ (900) ↓ 71.8 mm ⇔ 16.9 mm	No. 059  1 min 1 ■ (900) ↓ 35.8 mm ⇔ 12.0 mm	No. 067  1 min 1 ■ (900) ↓ 84.0 mm ⇔ 42.0 mm	No. 075  1 min 1 ■ (900) ↓ 57.0 mm ⇔ 24.5 mm
No. 052  1 min 1 ■ (900) ↓ 50.5 mm ⇔ 13.5 mm	No. 060  1 min 1 ■ (900) ↓ 28.0 mm ⇔ 39.9 mm	No. 068  1 min 1 ■ (900) ↓ 50.0 mm ⇔ 40.0 mm	No. 076  1 min 1 ■ (900) ↓ 30.0 mm ⇔ 10.0 mm

No. 077



1 min	
1	█ (900)
↓	42.0 mm
↔	8.5 mm

No. 085



1 min	
1	█ (900)
↓	38.0 mm
↔	9.0 mm

No. 093



1 min	
1	█ (900)
↓	33.6 mm
↔	7.0 mm

No. 078



1 min	
1	█ (900)
↓	29.5 mm
↔	10.0 mm

No. 086



1 min	
1	█ (900)
↓	36.0 mm
↔	12.5 mm

No. 094



1 min	
1	█ (900)
↓	18.4 mm
↔	7.5 mm

No. 079



1 min	
1	█ (900)
↓	39.0 mm
↔	20.0 mm

No. 087



1 min	
1	█ (900)
↓	30.0 mm
↔	12.0 mm

No. 095



1 min	
1	█ (900)
↓	32.0 mm
↔	4.0 mm

No. 080



1 min	
1	█ (900)
↓	49.0 mm
↔	18.0 mm

No. 088



1 min	
1	█ (900)
↓	44.7 mm
↔	10.0 mm

No. 096



1 min	
1	█ (900)
↓	14.0 mm
↔	12.0 mm

No. 081



1 min	
1	█ (900)
↓	39.0 mm
↔	12.5 mm

No. 089



1 min	
1	█ (900)
↓	59.5 mm
↔	9.0 mm

No. 097



1 min	
1	█ (900)
↓	30.0 mm
↔	9.0 mm

No. 082



1 min	
1	█ (900)
↓	49.0 mm
↔	10.0 mm

No. 090



1 min	
1	█ (900)
↓	35.6 mm
↔	9.0 mm

No. 098



1 min	
1	█ (900)
↓	30.0 mm
↔	6.0 mm

No. 083



1 min	
1	█ (900)
↓	36.4 mm
↔	10.0 mm

No. 091



1 min	
1	█ (900)
↓	33.6 mm
↔	7.0 mm

No. 099



1 min	
1	█ (900)
↓	16.0 mm
↔	6.0 mm

No. 084



1 min	
1	█ (900)
↓	53.0 mm
↔	12.0 mm

No. 092



1 min	
1	█ (900)
↓	33.6 mm
↔	7.0 mm

No. 100



1 min	
1	█ (900)
↓	36.0 mm
↔	6.0 mm

- Large buttonhole patterns
- Grands motifs de boutonnières
- Ricami per asole grandi
- Padrões de casas para botões grandes

- Muster für große Knopflöcher
- Grote knoopsgatpatronen
- Patrones para ojales de gran tamaño
- Большие петли для вышивания



No. 001

L: 2 min	L : ⚡ 9.1 mm
M: 1 min	↔ 99.8 mm
S: 1 min	M : ⚡ 8.5 mm
	↔ 75.0 mm
1 ■ (900)	S : ⚡ 7.9 mm
	↔ 50.0 mm

No. 006

L: 1 min	L : ⚡ 5.8 mm
M: 1 min	↔ 99.9 mm
S: 1 min	M : ⚡ 5.4 mm
	↔ 74.9 mm
1 ■ (900)	S : ⚡ 5.0 mm
	↔ 50.0 mm

No. 002

L: 1 min	L : ⚡ 9.1 mm
M: 1 min	↔ 99.9 mm
S: 1 min	M : ⚡ 8.5 mm
	↔ 75.0 mm
1 ■ (900)	S : ⚡ 7.9 mm
	↔ 50.0 mm

No. 007

L: 2 min	L : ⚡ 9.2 mm
M: 1 min	↔ 100.0 mm
S: 1 min	M : ⚡ 8.4 mm
	↔ 75.0 mm
1 ■ (900)	S : ⚡ 8.0 mm
	↔ 49.9 mm

No. 003

L: 2 min	L : ⚡ 9.1 mm
M: 1 min	↔ 99.8 mm
S: 1 min	M : ⚡ 8.5 mm
	↔ 74.9 mm
1 ■ (900)	S : ⚡ 7.9 mm
	↔ 50.0 mm

No. 008

L: 2 min	L : ⚡ 9.2 mm
M: 1 min	↔ 99.8 mm
S: 1 min	M : ⚡ 8.4 mm
	↔ 75.0 mm
1 ■ (900)	S : ⚡ 8.0 mm
	↔ 50.0 mm

No. 004

L: 1 min	L : ⚡ 5.8 mm
M: 1 min	↔ 99.8 mm
S: 1 min	M : ⚡ 5.4 mm
	↔ 74.9 mm
1 ■ (900)	S : ⚡ 5.0 mm
	↔ 50.0 mm

No. 009

L: 2 min	L : ⚡ 9.1 mm
M: 1 min	↔ 99.9 mm
S: 1 min	M : ⚡ 8.5 mm
	↔ 75.0 mm
1 ■ (900)	S : ⚡ 7.9 mm
	↔ 49.9 mm

No. 005

L: 2 min	L : ⚡ 9.1 mm
M: 1 min	↔ 99.8 mm
S: 1 min	M : ⚡ 8.5 mm
	↔ 74.9 mm
1 ■ (900)	S : ⚡ 7.9 mm
	↔ 50.0 mm

No. 010

L: 2 min	L : ⚡ 9.2 mm
M: 1 min	↔ 100.0 mm
S: 1 min	M : ⚡ 8.6 mm
	↔ 74.9 mm
1 ■ (900)	S : ⚡ 8.0 mm
	↔ 50.0 mm

- ◆ Monograms
- ◆ Monogrammes
- ◆ Monogrammi
- ◆ Monogramas

- ◆ Monogramme
- ◆ Monogrammen
- ◆ Monogramas
- ◆ Монограммы

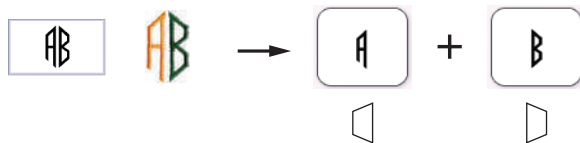
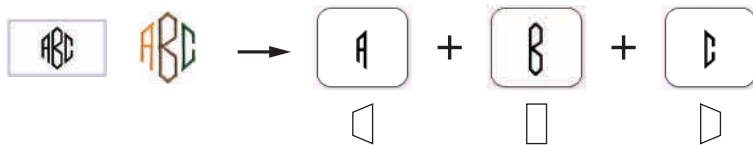

- Monogram Frames
- Encadrements pour monogrammes
- Cornici per monogramma
- Molduras de monograma

- Monogrammrahmen
- Monogramkaders en omrandingen
- Costuras de encuadre con texto de monograma
- Рамки для монограмм

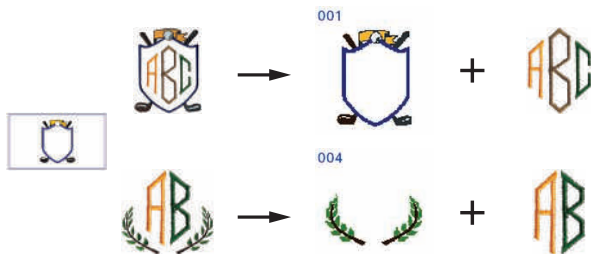

- Monogram Frames
- Encadrements pour monogrammes
- Cornici per monogramma
- Molduras de monograma

- Monogrammrahmen
- Monogramkaders en omrandingen
- Costuras de encuadre con texto de monograma
- Рамки для монограмм



No. 001

L: 6 min
M: 4 min
S: 3 min
1 (001)
2 (058)
3 (208)
4 (707)
5 (007)

L : \updownarrow 94.4 mm
 \updownarrow 73.6 mm
 M : \updownarrow 64.1 mm
 \updownarrow 50.1 mm
 S : \updownarrow 40.9 mm
 \updownarrow 31.2 mm

No. 008

L: 2 min
M: 2 min
S: 1 min
1 (507)
2 (800)

L : \updownarrow 94.9 mm
 \updownarrow 94.4 mm
 M : \updownarrow 63.6 mm
 \updownarrow 63.9 mm
 S : \updownarrow 39.9 mm
 \updownarrow 40.2 mm

No. 002

L: 6 min
M: 5 min
S: 4 min
1 (001)
2 (513)
3 (208)
4 (007)
5 (900)

L : \updownarrow 90.1 mm
 \updownarrow 81.6 mm
 M : \updownarrow 60.2 mm
 \updownarrow 54.9 mm
 S : \updownarrow 38.8 mm
 \updownarrow 36.1 mm

No. 009

L: 3 min
M: 2 min
S: 1 min
1 (900)
2 (515)
3 (214)

L : \updownarrow 94.6 mm
 \updownarrow 72.3 mm
 M : \updownarrow 59.5 mm
 \updownarrow 46.0 mm
 S : \updownarrow 37.2 mm
 \updownarrow 28.8 mm

No. 003

L: 3 min
M: 2 min
S: 1 min
1 (323)

L : \updownarrow 93.8 mm
 \updownarrow 64.5 mm
 M : \updownarrow 61.4 mm
 \updownarrow 42.6 mm
 S : \updownarrow 40.3 mm
 \updownarrow 27.5 mm

No. 010

L: 2 min
M: 1 min
S: 1 min
1 (534)

L : \updownarrow 83.4 mm
 \updownarrow 98.7 mm
 M : \updownarrow 56.1 mm
 \updownarrow 66.8 mm
 S : \updownarrow 35.1 mm
 \updownarrow 41.8 mm

No. 004

L: 3 min
M: 2 min
S: 2 min
1 (515)
2 (058)

L : \updownarrow 48.4 mm
 \updownarrow 92.5 mm
 M : \updownarrow 31.2 mm
 \updownarrow 59.5 mm
 S : \updownarrow 19.1 mm
 \updownarrow 36.4 mm

No. 011

L: 1 min
M: 1 min
S: 1 min
1 (620)

L : \updownarrow 25.2 mm
 \updownarrow 89.4 mm
 M : \updownarrow 16.8 mm
 \updownarrow 57.4 mm
 S : \updownarrow 9.1 mm
 \updownarrow 34.0 mm

No. 005

L: 2 min
M: 2 min
S: 1 min
1 (205)
2 (085)
3 (612)
4 (800)

L : \updownarrow 92.5 mm
 \updownarrow 78.9 mm
 M : \updownarrow 59.6 mm
 \updownarrow 50.9 mm
 S : \updownarrow 34.9 mm
 \updownarrow 29.7 mm

No. 012

L: 1 min
M: 1 min
S: 1 min
1 (070)
2 (612)

L : \updownarrow 22.7 mm
 \updownarrow 90.0 mm
 M : \updownarrow 14.5 mm
 \updownarrow 57.3 mm
 S : \updownarrow 8.9 mm
 \updownarrow 34.6 mm

No. 006

L: 4 min
M: 2 min
S: 1 min
1 (328)

L : \updownarrow 77.5 mm
 \updownarrow 78.2 mm
 M : \updownarrow 50.0 mm
 \updownarrow 50.4 mm
 S : \updownarrow 29.7 mm
 \updownarrow 29.9 mm

No. 013

L: 1 min
M: 1 min
S: 1 min
1 (208)

L : \updownarrow 28.3 mm
 \updownarrow 91.4 mm
 M : \updownarrow 18.4 mm
 \updownarrow 59.0 mm
 S : \updownarrow 11.5 mm
 \updownarrow 36.1 mm

No. 007

L: 2 min
M: 2 min
S: 1 min
1 (214)
2 (843)

L : \updownarrow 84.8 mm
 \updownarrow 84.8 mm
 M : \updownarrow 55.0 mm
 \updownarrow 54.9 mm
 S : \updownarrow 33.9 mm
 \updownarrow 33.9 mm

No. 014

L: 1 min
M: 1 min
S: 1 min
1 (800)

L : \updownarrow 24.4 mm
 \updownarrow 88.1 mm
 M : \updownarrow 15.1 mm
 \updownarrow 56.7 mm
 S : \updownarrow 8.4 mm
 \updownarrow 38.9 mm

No. 015

L: 2 min
M: 1 min
S: 1 min
1 (214)
2 (058)

L : \updownarrow 24.3 mm
 \updownarrow 54.4 mm
 M : \updownarrow 15.5 mm
 \updownarrow 34.7 mm
 S : \updownarrow 9.3 mm
 \updownarrow 20.8 mm

◆ Decorative Alphabet Patterns
 ◆ Motifs d'alphabet décoratif
 ◆ Ricami Alfabeto decorativo
 ◆ Padrões de alfabeto decorativo

- Floral Alphabet (Gold)
- Alphabet floral (doré)
- Alfabeto floreale (dorato)
- Alfabeto floral (dourado)

◆ Dekor-Buchstabenmuster
 ◆ Decoratieve sierlettertypen
 ◆ Patrones de alfabeto decorativo
 ◆ Декоративные шрифты

- Blumenbuchstaben (Gold)
- Bloemenalfabet (goud)
- Alfabeto floral (dorado)
- Цветочный шрифт (золотой)



No. 001

21 min	
1	(328)
2	(804)
3	(612)
4	(079)
5	(807)
6	(513)
7	(502)

↓ 145.1 mm
 ↔ 125.7 mm

No. 006

20 min	
1	(328)
2	(804)
3	(612)
4	(079)
5	(807)
6	(513)
7	(502)

↓ 142.8 mm
 ↔ 101.8 mm

No. 011

25 min	
1	(328)
2	(804)
3	(612)
4	(079)
5	(807)
6	(513)
7	(502)

↓ 142.0 mm
 ↔ 119.6 mm

No. 002

24 min	
1	(328)
2	(804)
3	(612)
4	(079)
5	(807)
6	(513)
7	(502)

↓ 140.9 mm
 ↔ 108.1 mm

No. 007

23 min	
1	(328)
2	(804)
3	(612)
4	(079)
5	(807)
6	(513)
7	(502)

↓ 141.6 mm
 ↔ 117.3 mm

No. 012

18 min	
1	(328)
2	(804)
3	(612)
4	(079)
5	(807)
6	(513)
7	(502)

↓ 144.9 mm
 ↔ 107.0 mm

No. 003

21 min	
1	(328)
2	(804)
3	(612)
4	(079)
5	(807)
6	(513)
7	(502)

↓ 141.8 mm
 ↔ 114.5 mm

No. 008

26 min	
1	(328)
2	(804)
3	(612)
4	(079)
5	(807)
6	(513)
7	(502)

↓ 141.7 mm
 ↔ 121.6 mm

No. 013

28 min	
1	(328)
2	(804)
3	(612)
4	(079)
5	(807)
6	(513)
7	(502)

↓ 146.5 mm
 ↔ 124.6 mm

No. 004

23 min	
1	(328)
2	(804)
3	(612)
4	(079)
5	(807)
6	(513)
7	(502)

↓ 141.2 mm
 ↔ 108.3 mm

No. 009

17 min	
1	(328)
2	(804)
3	(612)
4	(079)
5	(807)
6	(513)
7	(502)

↓ 145.8 mm
 ↔ 49.7 mm

No. 014

24 min	
1	(328)
2	(804)
3	(612)
4	(079)
5	(807)
6	(513)
7	(502)

↓ 147.0 mm
 ↔ 116.8 mm

No. 005

23 min	
1	(328)
2	(804)
3	(612)
4	(079)
5	(807)
6	(513)
7	(502)

↓ 144.3 mm
 ↔ 102.5 mm

No. 010

18 min	
1	(328)
2	(804)
3	(612)
4	(079)
5	(807)
6	(513)
7	(502)

↓ 144.5 mm
 ↔ 82.3 mm

No. 015

23 min	
1	(328)
2	(804)
3	(612)
4	(079)
5	(807)
6	(513)
7	(502)

↓ 146.3 mm
 ↔ 115.3 mm

No. 016



21 min	
1	(328)
2	(804)
3	(612)
4	(079)
5	(807)
6	(513)
7	(502)

↓ 143.4 mm
 ↔ 99.6 mm

No. 020



21 min	
1	(328)
2	(804)
3	(612)
4	(079)
5	(807)
6	(513)
7	(502)

↓ 144.5 mm
 ↔ 118.4 mm

No. 024



22 min	
1	(328)
2	(804)
3	(612)
4	(079)
5	(807)
6	(513)
7	(502)

↓ 142.3 mm
 ↔ 115.9 mm

No. 017



25 min	
1	(328)
2	(804)
3	(612)
4	(079)
5	(807)
6	(513)
7	(502)

↓ 142.7 mm
 ↔ 118.2 mm

No. 021



21 min	
1	(328)
2	(804)
3	(612)
4	(079)
5	(807)
6	(513)
7	(502)

↓ 144.6 mm
 ↔ 118.5 mm

No. 025



20 min	
1	(328)
2	(804)
3	(612)
4	(079)
5	(807)
6	(513)
7	(502)

↓ 142.8 mm
 ↔ 116.3 mm

No. 018



25 min	
1	(328)
2	(804)
3	(612)
4	(079)
5	(807)
6	(513)
7	(502)

↓ 143.4 mm
 ↔ 112.5 mm

No. 022



21 min	
1	(328)
2	(804)
3	(612)
4	(079)
5	(807)
6	(513)
7	(502)

↓ 145.5 mm
 ↔ 121.5 mm

No. 026



23 min	
1	(328)
2	(804)
3	(612)
4	(079)
5	(807)
6	(513)
7	(502)

↓ 142.8 mm
 ↔ 92.9 mm

No. 019



25 min	
1	(328)
2	(804)
3	(612)
4	(079)
5	(807)
6	(513)
7	(502)

↓ 144.1 mm
 ↔ 99.4 mm

No. 023



28 min	
1	(328)
2	(804)
3	(612)
4	(079)
5	(807)
6	(513)
7	(502)

↓ 146.2 mm
 ↔ 124.8 mm

◆ Example ◆ Beispiel ◆ Exemple ◆ Voorbeeld
 ◆ Esemplio ◆ Ejemplo ◆ Exemplo ◆ Пример

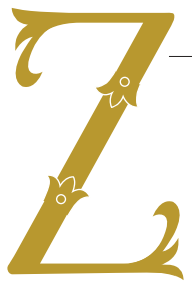

23 min	
1	(328)
2	(804)
3	(612)
4	(079)
5	(807)
6	(513)
7	(502)

↓ 142.8 mm
 ↔ 92.9 mm

No. 027



4 min	
1	(328)
2	(079)
3	(807)
4	(513)
5	(502)

↓ 51.9 mm
 ↔ 45.9 mm

No. 029



4 min	
1	(328)
2	(079)
3	(807)
4	(513)
5	(502)

↓ 52.2 mm
 ↔ 41.1 mm

No. 031



5 min	
1	(328)
2	(079)
3	(807)
4	(513)
5	(502)

↓ 53.1 mm
 ↔ 37.3 mm

No. 028



4 min	
1	(328)
2	(079)
3	(807)
4	(513)
5	(502)

↓ 51.7 mm
 ↔ 39.6 mm

No. 030



4 min	
1	(328)
2	(079)
3	(807)
4	(513)
5	(502)

↓ 51.9 mm
 ↔ 39.3 mm

No. 032



4 min	
1	(328)
2	(079)
3	(807)
4	(513)
5	(502)

↓ 52.1 mm
 ↔ 36.6 mm

No. 033



4 min	
1	(328)
2	(079)
3	(807)
4	(513)
5	(502)

↓ 51.9 mm
↔ 42.7 mm

No. 038



4 min	
1	(328)
2	(079)
3	(807)
4	(513)
5	(502)

↓ 52.5 mm
↔ 38.9 mm

No. 043



4 min	
1	(328)
2	(079)
3	(807)
4	(513)
5	(502)

↓ 52.6 mm
↔ 43.3 mm

No. 048



4 min	
1	(328)
2	(079)
3	(807)
4	(513)
5	(502)

↓ 52.8 mm
↔ 43.9 mm

No. 034



5 min	
1	(328)
2	(079)
3	(807)
4	(513)
5	(502)

↓ 52.2 mm
↔ 44.3 mm

No. 039



6 min	
1	(328)
2	(079)
3	(807)
4	(513)
5	(502)

↓ 53.3 mm
↔ 46.4 mm

No. 044



5 min	
1	(328)
2	(079)
3	(807)
4	(513)
5	(502)

↓ 52.3 mm
↔ 40.7 mm

No. 049



5 min	
1	(328)
2	(079)
3	(807)
4	(513)
5	(502)

↓ 53.3 mm
↔ 46.5 mm

No. 035



4 min	
1	(328)
2	(079)
3	(807)
4	(513)
5	(502)

↓ 53.9 mm
↔ 23.8 mm

No. 040



5 min	
1	(328)
2	(079)
3	(807)
4	(513)
5	(502)

↓ 52.9 mm
↔ 43.1 mm

No. 045



4 min	
1	(328)
2	(079)
3	(807)
4	(513)
5	(502)

↓ 52.6 mm
↔ 35.0 mm

No. 050



4 min	
1	(328)
2	(079)
3	(807)
4	(513)
5	(502)

↓ 51.7 mm
↔ 42.0 mm

No. 036



4 min	
1	(328)
2	(079)
3	(807)
4	(513)
5	(502)

↓ 52.6 mm
↔ 30.1 mm

No. 041



4 min	
1	(328)
2	(079)
3	(807)
4	(513)
5	(502)

↓ 52.8 mm
↔ 42.6 mm

No. 046



4 min	
1	(328)
2	(079)
3	(807)
4	(513)
5	(502)

↓ 53.0 mm
↔ 42.0 mm

No. 051



4 min	
1	(328)
2	(079)
3	(807)
4	(513)
5	(502)

↓ 53.8 mm
↔ 42.2 mm

No. 037



5 min	
1	(328)
2	(079)
3	(807)
4	(513)
5	(502)

↓ 52.4 mm
↔ 43.4 mm

No. 042



4 min	
1	(328)
2	(079)
3	(807)
4	(513)
5	(502)

↓ 52.1 mm
↔ 36.9 mm

No. 047



4 min	
1	(328)
2	(079)
3	(807)
4	(513)
5	(502)

↓ 52.5 mm
↔ 42.8 mm

No. 052



4 min	
1	(328)
2	(079)
3	(807)
4	(513)
5	(502)

↓ 52.4 mm
↔ 33.4 mm

No. 053



4 min	
1	(804)
2	(612)
3	(079)
4	(807)
5	(513)
6	(502)

↓ 34.4 mm
↔ 22.7 mm

No. 055



6 min					
1 (804)	3 (079)	5 (513)	2 (612)	4 (807)	6 (502)

↓ 39.3 mm ↔ 75.4 mm

No. 057



11 min															
1 (804)	7 (804)	13 (079)	2 (612)	8 (612)	14 (807)	3 (079)	9 (079)	15 (513)	4 (807)	10 (807)	16 (502)	5 (513)	11 (513)	6 (502)	12 (502)

↓ 27.9 mm ↔ 121.9 mm

No. 054



2 min	
1	(079)
2	(807)
3	(513)
4	(502)

↓ 39.8 mm
↔ 25.6 mm

No. 056



10 min											
1 (804)	5 (513)	9 (079)	2 (612)	6 (502)	10 (807)	3 (079)	7 (804)	11 (513)	4 (807)	8 (612)	12 (502)

↓ 23.4 mm ↔ 123.7 mm

Embroidery Pattern Color Change Table
 Tableau de changement des couleurs des motifs de broderie
 Tabella dei cambi colore dei ricami
 Tabela de alteração de cor de padrões de bordado

Stickdesign-Farbtabelle
 Kleurenvorgorde voor de borduurpatronen
 Tabla de cambio de color para patrones de bordado
 Таблицы цветов нитей для вышивок



No. 058

21 min		
1 (079)	7 (513)	13 (079)
2 (807)	8 (502)	14 (807)
3 (513)	9 (079)	15 (513)
4 (502)	10 (807)	16 (502)
5 (079)	11 (513)	
6 (807)	12 (502)	

↕ 103.6 mm ↔ 94.9 mm



No. 060

9 min	
1 (513)	
2 (807)	
3 (513)	
4 (807)	

↕ 106.7 mm
 ↔ 93.4 mm



No. 063

1 min	
1 (513)	

↕ 147.2 mm
 ↔ 61.8 mm



No. 059

43 min		
1 (079)	17 (513)	33 (804)
2 (807)	18 (502)	34 (612)
3 (804)	19 (079)	35 (513)
4 (612)	20 (807)	36 (502)
5 (513)	21 (804)	37 (079)
6 (502)	22 (612)	38 (807)
7 (079)	23 (513)	39 (804)
8 (807)	24 (502)	40 (612)
9 (804)	25 (079)	41 (513)
10 (612)	26 (807)	42 (502)
11 (513)	27 (804)	43 (079)
12 (502)	28 (612)	44 (807)
13 (079)	29 (513)	45 (804)
14 (807)	30 (502)	46 (612)
15 (804)	31 (079)	47 (513)
16 (612)	32 (807)	48 (502)

↕ 195.4 mm ↔ 157.3 mm



No. 061

6 min	
1 (513)	
2 (807)	
3 (513)	
4 (807)	

↕ 42.6 mm
 ↔ 142.0 mm



No. 064

14 min	
1 (804)	13 (804)
2 (612)	14 (612)
3 (079)	15 (079)
4 (807)	16 (807)
5 (513)	17 (513)
6 (502)	18 (502)
7 (804)	19 (804)
8 (612)	20 (612)
9 (079)	21 (079)
10 (807)	22 (807)
11 (513)	23 (513)
12 (502)	24 (502)

↕ 73.3 mm ↔ 72.8 mm



No. 062

19 min		
1 (513)	4 (807)	7 (513)
2 (807)	5 (513)	8 (807)
3 (513)	6 (807)	

↕ 195.4 mm ↔ 158.5 mm

- Floral Alphabet (Blue)
- Alphabet floral (bleu)
- Alfabeto floreale (blu)
- Alfabeto floral (azul)

- Blumenbuchstaben (Blau)
- Bloemenalfabet (blauw)
- Alfabeto floral (azul)
- Цветочный шрифт (голубой)



No. 001 **15 min**

1	(017)
2	(513)
3	(810)
4	(070)
5	(612)
6	(205)

↓ 125.9 mm
↔ 78.6 mm

No. 006 **21 min**

1	(017)
2	(513)
3	(070)
4	(810)
5	(205)
6	(612)

↓ 125.9 mm
↔ 81.4 mm

No. 011 **21 min**

1	(017)
2	(513)
3	(810)
4	(612)
5	(205)
6	(070)

↓ 125.8 mm
↔ 87.8 mm

No. 002 **19 min**

1	(017)
2	(513)
3	(810)
4	(205)
5	(070)
6	(612)

↓ 127.4 mm
↔ 83.1 mm

No. 007 **18 min**

1	(017)
2	(513)
3	(205)
4	(612)
5	(070)
6	(810)

↓ 126.6 mm
↔ 84.0 mm

No. 012 **12 min**

1	(017)
2	(513)
3	(810)
4	(205)
5	(612)
6	(070)

↓ 126.0 mm
↔ 77.2 mm

No. 003 **15 min**

1	(017)
2	(513)
3	(810)
4	(205)
5	(612)
6	(070)

↓ 125.8 mm
↔ 81.7 mm

No. 008 **18 min**

1	(017)
2	(513)
3	(612)
4	(810)
5	(205)
6	(070)

↓ 126.0 mm
↔ 90.4 mm

No. 013 **23 min**

1	(017)
2	(513)
3	(205)
4	(612)
5	(810)
6	(070)

↓ 125.9 mm
↔ 103.7 mm

No. 004 **17 min**

1	(017)
2	(513)
3	(205)
4	(810)
5	(612)
6	(070)

↓ 127.2 mm
↔ 86.3 mm

No. 009 **11 min**

1	(017)
2	(513)
3	(612)
4	(810)
5	(070)
6	(205)

↓ 125.9 mm
↔ 26.1 mm

No. 014 **16 min**

1	(017)
2	(513)
3	(070)
4	(810)
5	(612)
6	(205)

↓ 125.8 mm
↔ 86.6 mm

No. 005 **21 min**

1	(017)
2	(513)
3	(810)
4	(070)
5	(612)
6	(205)

↓ 126.1 mm
↔ 85.9 mm

No. 010 **10 min**

1	(017)
2	(513)
3	(612)
4	(810)
5	(070)
6	(205)

↓ 125.8 mm
↔ 49.8 mm

No. 015 **16 min**

1	(017)
2	(513)
3	(612)
4	(810)
5	(070)
6	(205)

↓ 125.3 mm
↔ 95.0 mm

No. 016 **13 min**



1	(017)
2	(513)
3	(810)
4	(070)
5	(205)
6	(612)

↓ 126.0 mm
 ↔ 73.4 mm

No. 022 **13 min**

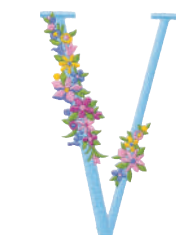

1	(017)
2	(513)
3	(810)
4	(070)
5	(612)
6	(205)

↓ 126.0 mm
 ↔ 77.8 mm

No. 027 **5 min**



1	(017)
---	-------

↓ 79.8 mm
 ↔ 58.8 mm

No. 017 **22 min**



1	(017)
2	(513)
3	(810)
4	(612)
5	(205)
6	(070)

↓ 129.4 mm
 ↔ 95.3 mm

No. 023 **24 min**



1	(017)
2	(513)
3	(612)
4	(810)
5	(070)
6	(205)

↓ 125.8 mm
 ↔ 119.4 mm

No. 028 **6 min**



1	(017)
---	-------

↓ 125.9 mm
 ↔ 60.7 mm

No. 018 **17 min**



1	(017)
2	(513)
3	(612)
4	(070)
5	(810)
6	(205)

↓ 126.0 mm
 ↔ 83.0 mm

No. 024 **17 min**

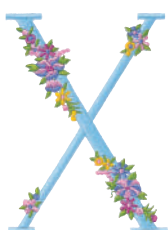

1	(017)
2	(513)
3	(070)
4	(810)
5	(205)
6	(612)

↓ 126.1 mm
 ↔ 91.6 mm

No. 029 **4 min**



1	(017)
---	-------

↓ 83.1 mm
 ↔ 56.2 mm

No. 019 **15 min**



1	(017)
2	(513)
3	(810)
4	(612)
5	(205)
6	(070)

↓ 125.9 mm
 ↔ 70.3 mm

No. 025 **15 min**



1	(017)
2	(513)
3	(070)
4	(810)
5	(612)
6	(205)

↓ 125.9 mm
 ↔ 84.8 mm

No. 030 **6 min**



1	(017)
---	-------

↓ 125.9 mm
 ↔ 60.7 mm

No. 020 **14 min**

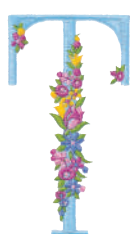

1	(017)
2	(513)
3	(810)
4	(205)
5	(612)
6	(070)

↓ 126.1 mm
 ↔ 70.0 mm

No. 026 **15 min**



1	(017)
2	(513)
3	(810)
4	(205)
5	(612)
6	(070)

↓ 125.9 mm
 ↔ 70.0 mm

No. 031 **4 min**



1	(017)
---	-------

↓ 82.9 mm
 ↔ 56.7 mm

No. 021 **13 min**



1	(017)
2	(513)
3	(810)
4	(612)
5	(070)
6	(205)

↓ 126.1 mm
 ↔ 79.9 mm

No. 032 **4 min**

1	(017)
---	-------

↓ 126.0 mm
 ↔ 55.4 mm

No. 033 **8 min**



1	(017)
---	-------

↓ 125.9 mm
 ↔ 86.3 mm

h

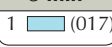
No. 034 **5 min**
1  (017)
↓ 126.0 mm
↔ 62.8 mm

o

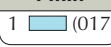
No. 041 **4 min**
1  (017)
↓ 82.0 mm
↔ 55.8 mm

v

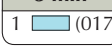
No. 048 **3 min**
1  (017)
↓ 79.8 mm
↔ 56.7 mm

i

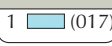
No. 035 **3 min**
1  (017)
↓ 110.0 mm
↔ 19.4 mm

p

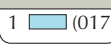
No. 042 **6 min**
1  (017)
↓ 126.0 mm
↔ 68.7 mm

w

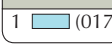
No. 049 **6 min**
1  (017)
↓ 80.0 mm
↔ 82.2 mm

j

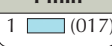
No. 036 **4 min**
1  (017)
↓ 157.9 mm
↔ 39.9 mm

q

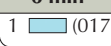
No. 043 **6 min**
1  (017)
↓ 126.0 mm
↔ 68.7 mm

x

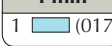
No. 050 **4 min**
1  (017)
↓ 80.0 mm
↔ 59.9 mm

k

No. 037 **6 min**
1  (017)
↓ 126.0 mm
↔ 66.4 mm

r

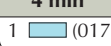
No. 044 **4 min**
1  (017)
↓ 80.5 mm
↔ 54.0 mm

y

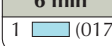
No. 051 **6 min**
1  (017)
↓ 125.8 mm
↔ 84.7 mm

l

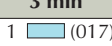
No. 038 **3 min**
1  (017)
↓ 126.0 mm
↔ 19.5 mm

s

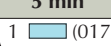
No. 045 **5 min**
1  (017)
↓ 81.1 mm
↔ 50.1 mm

z

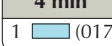
No. 052 **4 min**
1  (017)
↓ 79.9 mm
↔ 52.2 mm

m

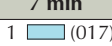
No. 039 **7 min**
1  (017)
↓ 80.1 mm
↔ 90.2 mm

t

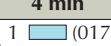
No. 046 **4 min**
1  (017)
↓ 127.1 mm
↔ 51.8 mm

n

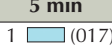
No. 040 **5 min**
1  (017)
↓ 80.0 mm
↔ 65.3 mm

u

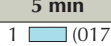
No. 047 **5 min**
1  (017)
↓ 80.0 mm
↔ 65.3 mm



No. 053

6 min	
1	(513)
2	(612)
3	(810)
4	(070)
5	(205)
↓ 95.4 mm	
↔ 24.7 mm	



No. 054

5 min	
1	(513)
2	(810)
3	(612)
4	(205)
5	(070)
↓ 47.9 mm	
↔ 20.5 mm	



No. 055

2 min	
1	(513)
2	(810)
3	(205)
4	(612)
↓ 25.7 mm	
↔ 17.0 mm	



No. 056

2 min	
1	(513)
2	(810)
3	(070)
4	(612)
↓ 25.8 mm	
↔ 24.0 mm	



No. 057

1 min	
1	(513)
2	(070)
3	(810)
↓ 17.9 mm	
↔ 13.1 mm	



No. 058

66 min	
1	(513)
2	(070)
3	(124)
4	(086)
5	(205)
6	(513)
7	(070)
8	(124)
9	(086)
10	(205)
↓ 198.8 mm	
↔ 239.3 mm	



No. 059

14 min	
1	(513)
2	(070)
3	(810)
4	(612)
5	(205)
↓ 76.2 mm	
↔ 95.8 mm	



No. 060

11 min	
1	(513)
2	(070)
3	(810)
4	(612)
5	(205)
↓ 37.6 mm	
↔ 109.4 mm	



No. 061

9 min	
1	(513)
2	(070)
3	(810)
4	(612)
5	(205)
↓ 41.6 mm	
↔ 79.8 mm	

- Floral Alphabet
- Alphabet floral
- Alfabeto floreale
- Alfabeto floral

- Blumenbuchstaben
- Bloemenalfabet (intern)
- Alfabeto floral
- Цветочный шрифт

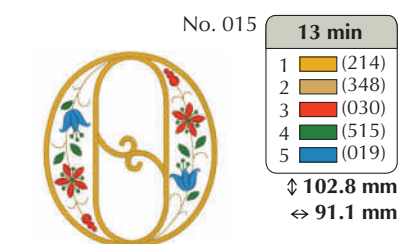
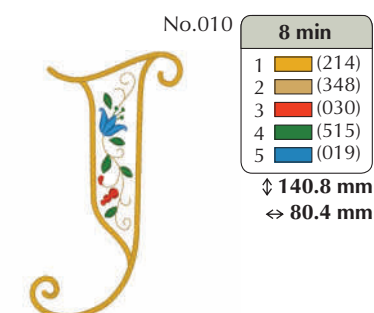
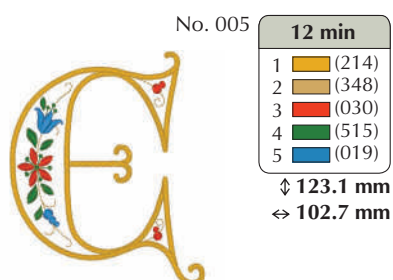
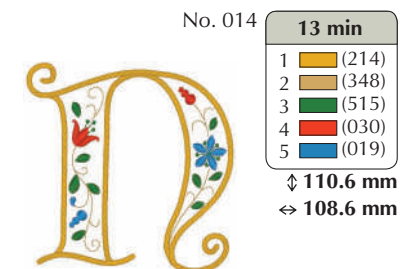
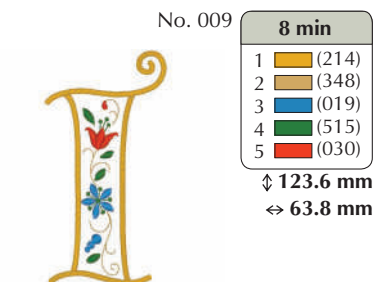
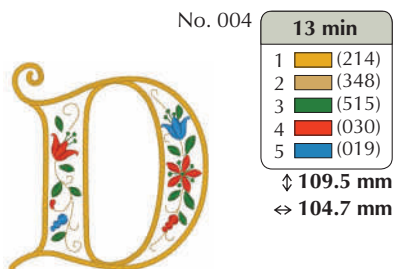
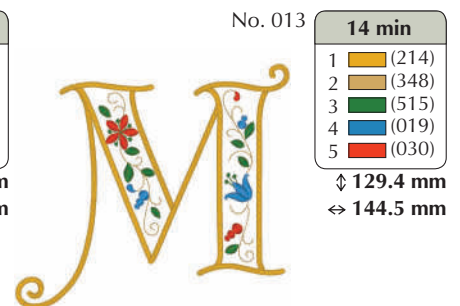
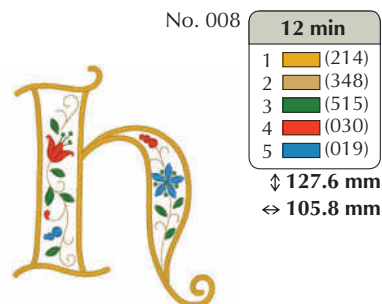
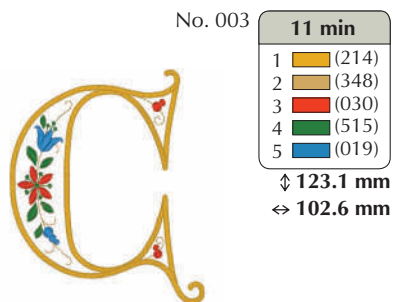
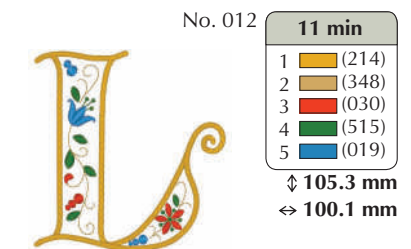
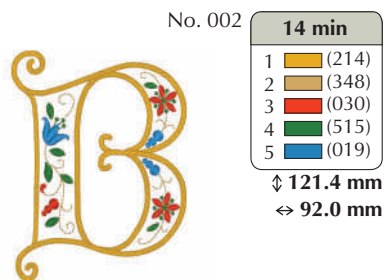
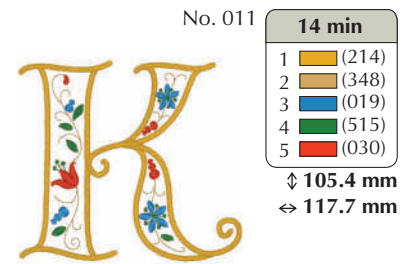
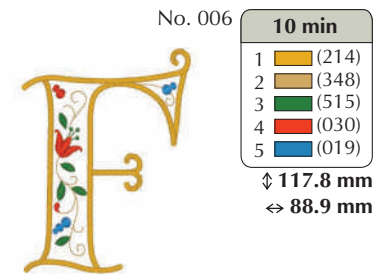

No. 016



12 min	
1	(214)
2	(348)
3	(030)
4	(515)
5	(019)

↓ 112.1 mm
 ⇔ 101.7 mm

No. 022



10 min	
1	(214)
2	(348)
3	(019)
4	(515)
5	(030)

↓ 126.0 mm
 ⇔ 123.4 mm

No. 027



1 min	
1	(214)
2	(030)
3	(515)

↓ 18.2 mm
 ⇔ 22.4 mm

No. 017



13 min	
1	(214)
2	(348)
3	(019)
4	(515)
5	(030)

↓ 120.7 mm
 ⇔ 93.2 mm

No. 023



13 min	
1	(214)
2	(348)
3	(030)
4	(515)
5	(019)

↓ 102.2 mm
 ⇔ 125.7 mm

No. 028



9 min	
1	(214)
2	(515)
3	(019)
4	(030)

↓ 49.3 mm
 ⇔ 186.1 mm

No. 018



14 min	
1	(214)
2	(348)
3	(019)
4	(515)
5	(030)

↓ 113.9 mm
 ⇔ 110.4 mm

No. 024



15 min	
1	(214)
2	(348)
3	(515)
4	(030)
5	(019)

↓ 103.7 mm
 ⇔ 121.6 mm

No. 029



6 min	
1	(019)
2	(214)
3	(030)

↓ 57.3 mm
 ⇔ 172.8 mm

No. 019



12 min	
1	(214)
2	(348)
3	(019)
4	(515)
5	(030)

↓ 121.0 mm
 ⇔ 93.8 mm

No. 025



11 min	
1	(214)
2	(348)
3	(019)
4	(515)
5	(030)

↓ 138.1 mm
 ⇔ 120.0 mm

No. 030



6 min	
1	(214)
2	(030)
3	(019)

↓ 40.9 mm
 ⇔ 179.5 mm

No. 020



11 min	
1	(214)
2	(348)
3	(019)
4	(515)
5	(030)

↓ 102.5 mm
 ⇔ 104.1 mm

No. 026



12 min	
1	(214)
2	(348)
3	(019)
4	(515)
5	(030)

↓ 104.8 mm
 ⇔ 120.9 mm

No. 021



10 min	
1	(214)
2	(348)
3	(515)
4	(019)
5	(030)

↓ 103.2 mm
 ⇔ 108.0 mm

◆ Example
 ◆ Beispiel
 ◆ Exemple
 ◆ Voorbeeld
 ◆ Esempio
 ◆ Ejemplo
 ◆ Exemplo
 ◆ Пример

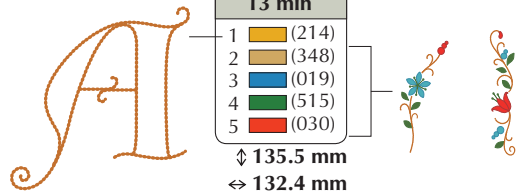

13 min	
1	(214)
2	(348)
3	(019)
4	(515)
5	(030)

↓ 135.5 mm
 ⇔ 132.4 mm

- Split Monogram
- Monogramme fractionné
- Monogramma diviso
- Monograma dividido

- Geteiltes Monogramm
- Gesplitst monogram
- Monograma dividido
- Разделенные монограммы

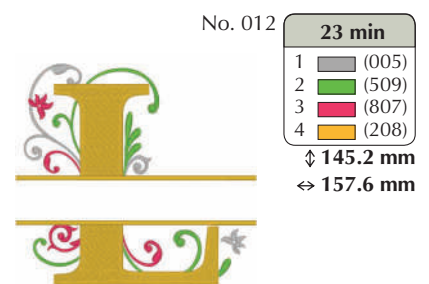
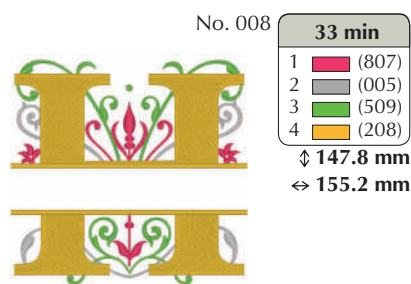
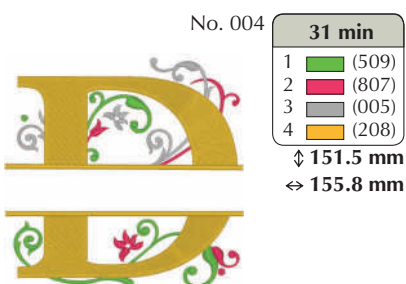
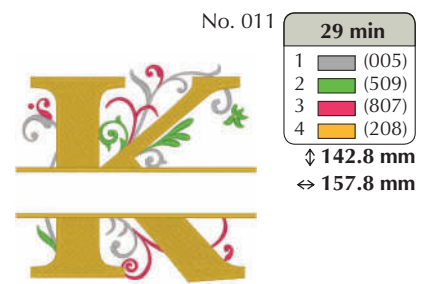
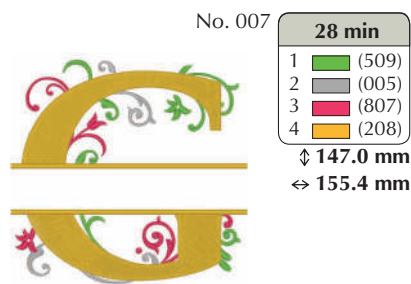
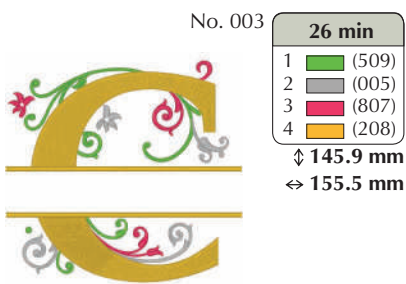
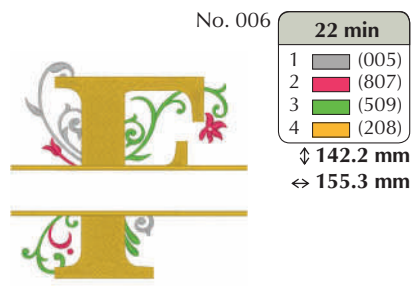
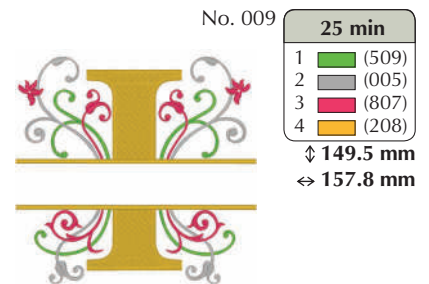
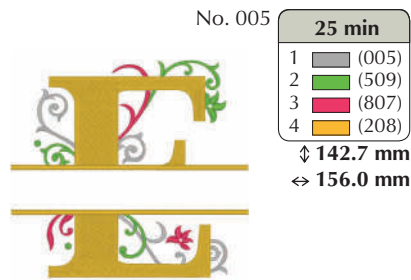
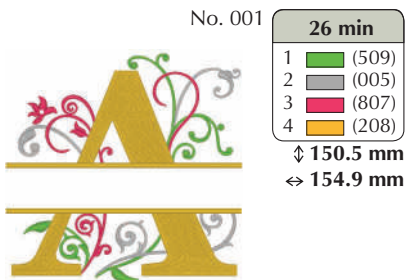

No. 013

31 min	
1	■ (005)
2	■ (509)
3	■ (807)
4	■ (208)

↓ 152.0 mm
 ↔ 157.8 mm

No. 018

28 min	
1	■ (005)
2	■ (509)
3	■ (807)
4	■ (208)

↓ 145.6 mm
 ↔ 155.2 mm

No. 023

29 min	
1	■ (509)
2	■ (005)
3	■ (807)
4	■ (208)

↓ 142.4 mm
 ↔ 155.4 mm

No. 014

28 min	
1	■ (509)
2	■ (807)
3	■ (005)
4	■ (208)

↓ 143.6 mm
 ↔ 157.8 mm

No. 019

24 min	
1	■ (005)
2	■ (509)
3	■ (807)
4	■ (208)

↓ 147.3 mm
 ↔ 154.8 mm

No. 024

25 min	
1	■ (509)
2	■ (005)
3	■ (807)
4	■ (208)

↓ 144.2 mm
 ↔ 155.1 mm

No. 015

32 min	
1	■ (005)
2	■ (807)
3	■ (509)
4	■ (208)

↓ 146.2 mm
 ↔ 152.8 mm

No. 020

26 min	
1	■ (807)
2	■ (509)
3	■ (005)
4	■ (208)

↓ 150.3 mm
 ↔ 154.9 mm

No. 025

25 min	
1	■ (509)
2	■ (005)
3	■ (807)
4	■ (208)

↓ 141.9 mm
 ↔ 155.1 mm

No. 016

23 min	
1	■ (005)
2	■ (509)
3	■ (807)
4	■ (208)

↓ 141.4 mm
 ↔ 152.2 mm

No. 021

24 min	
1	■ (509)
2	■ (005)
3	■ (807)
4	■ (208)

↓ 142.7 mm
 ↔ 154.9 mm

No. 026

26 min	
1	■ (005)
2	■ (807)
3	■ (509)
4	■ (208)

↓ 149.1 mm
 ↔ 155.1 mm

No. 017

30 min	
1	■ (005)
2	■ (509)
3	■ (807)
4	■ (208)

↓ 149.3 mm
 ↔ 155.0 mm

No. 022

23 min	
1	■ (005)
2	■ (807)
3	■ (509)
4	■ (208)

↓ 150.4 mm
 ↔ 155.0 mm

- Calligraphy
- Calligraphie
- Calligrafia
- Caligrafia

- Kalligrafie
- Kalligrafie
- Caligrafía
- Каллиграфический шрифт



No. 001

10 min

1 (900)

↓ 129.3 mm

↔ 155.4 mm

No. 005

10 min

1 (900)

↓ 125.6 mm

↔ 84.2 mm

No. 009

8 min

1 (900)

↓ 128.2 mm

↔ 103.8 mm

No. 002

11 min

1 (900)

↓ 132.8 mm

↔ 97.7 mm

No. 006

9 min

1 (900)

↓ 130.3 mm

↔ 118.5 mm

No. 010

10 min

1 (900)

↓ 154.1 mm

↔ 108.5 mm

No. 003

9 min

1 (900)

↓ 127.0 mm

↔ 88.6 mm

No. 007

10 min

1 (900)

↓ 134.2 mm

↔ 82.5 mm

No. 011

13 min

1 (900)

↓ 141.8 mm

↔ 145.5 mm

No. 004

12 min

1 (900)

↓ 125.7 mm

↔ 103.3 mm

No. 008

11 min

1 (900)

↓ 134.2 mm

↔ 143.4 mm

No. 012

12 min

1 (900)

↓ 144.5 mm

↔ 141.7 mm

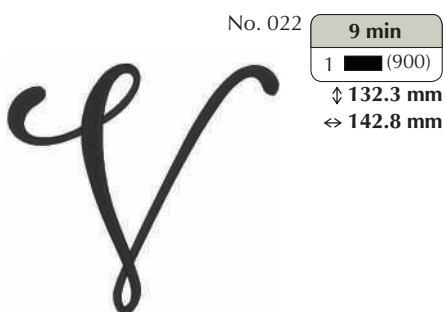
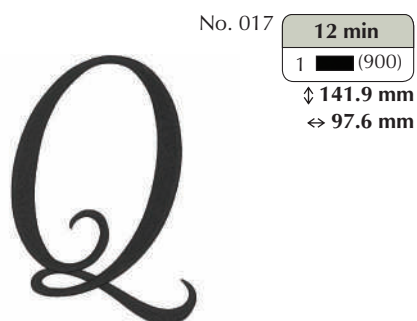
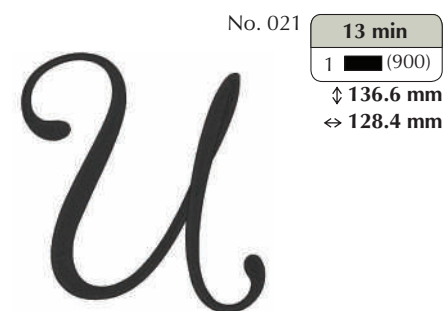
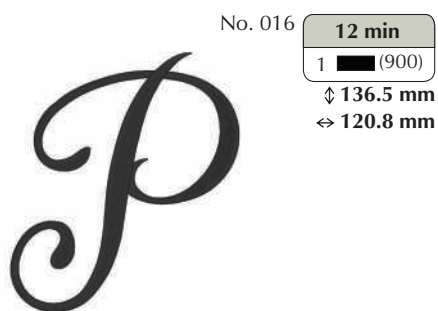
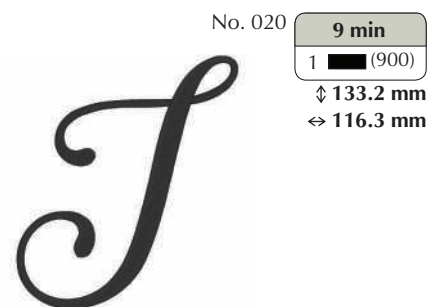
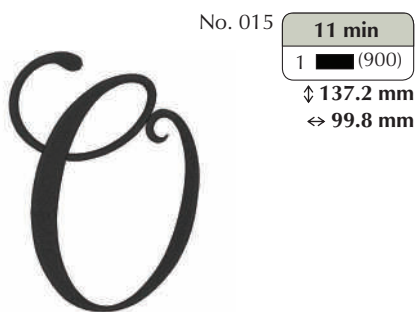
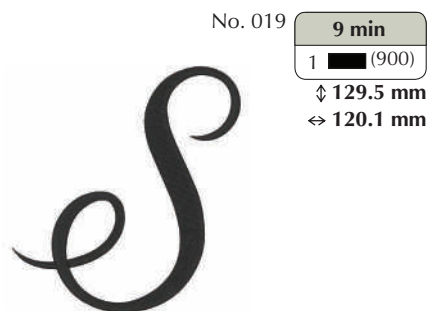
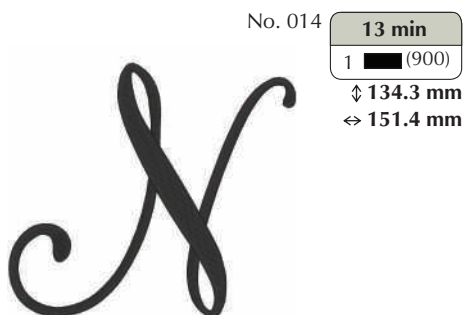
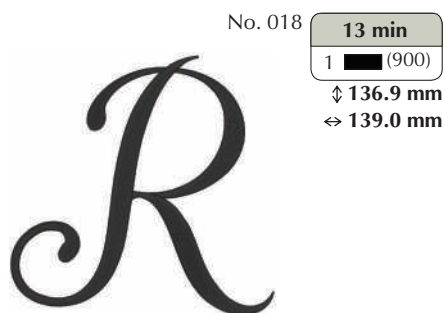
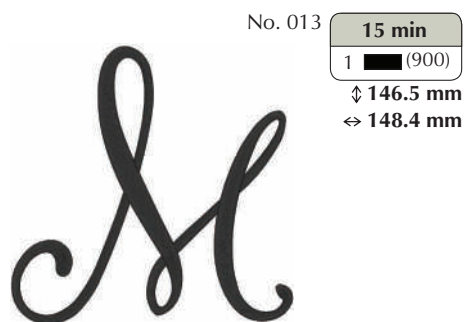

No. 023 **15 min**
1  (900)
↓ 140.0 mm
↔ 158.1 mm





No. 028 **8 min**
1  (900)
↓ 112.6 mm
↔ 55.1 mm





No. 034 **7 min**
1  (900)
↓ 113.2 mm
↔ 58.4 mm





No. 024 **13 min**
1  (900)
↓ 134.4 mm
↔ 117.2 mm





No. 029 **3 min**
1  (900)
↓ 57.8 mm
↔ 45.7 mm





No. 035 **3 min**
1  (900)
↓ 66.2 mm
↔ 31.0 mm



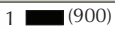

No. 025 **11 min**
1  (900)
↓ 138.1 mm
↔ 95.9 mm





No. 030 **8 min**
1  (900)
↓ 120.5 mm
↔ 75.4 mm





No. 036 **5 min**
1  (900)
↓ 115.3 mm
↔ 58.4 mm





No. 031 **4 min**
1  (900)
↓ 58.9 mm
↔ 47.7 mm





No. 037 **8 min**
1  (900)
↓ 113.4 mm
↔ 61.8 mm





No. 026 **12 min**
1  (900)
↓ 137.6 mm
↔ 148.9 mm





No. 032 **7 min**
1  (900)
↓ 145.7 mm
↔ 49.4 mm





No. 038 **5 min**
1  (900)
↓ 112.9 mm
↔ 44.5 mm



No. 027 **5 min**
1  (900)
↓ 58.0 mm
↔ 62.8 mm

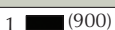



No. 033 **7 min**
1  (900)
↓ 111.4 mm
↔ 63.7 mm























No. 039 **8 min**
1  (900)
↓ 61.5 mm
↔ 80.5 mm





No. 040 **5 min**
1  (900)
↓ 61.6 mm
↔ 61.9 mm





<p>No. 041</p>  <p>4 min 1 (900) ↓ 62.1 mm ↔ 54.0 mm</p>	<p>No. 048</p>  <p>4 min 1 (900) ↓ 61.9 mm ↔ 51.6 mm</p>	<p>No. 055</p>  <p>6 min 1 (900) ↓ 96.0 mm ↔ 71.1 mm</p>
<p>No. 042</p>  <p>6 min 1 (900) ↓ 109.1 mm ↔ 67.3 mm</p>	<p>No. 049</p>  <p>6 min 1 (900) ↓ 61.8 mm ↔ 77.6 mm</p>	<p>No. 056</p>  <p>7 min 1 (900) ↓ 97.9 mm ↔ 62.1 mm</p>
<p>No. 043</p>  <p>7 min 1 (900) ↓ 112.9 mm ↔ 60.8 mm</p>	<p>No. 050</p>  <p>3 min 1 (900) ↓ 58.5 mm ↔ 63.2 mm</p>	<p>No. 057</p>  <p>6 min 1 (900) ↓ 96.0 mm ↔ 62.7 mm</p>
<p>No. 044</p>  <p>4 min 1 (900) ↓ 65.5 mm ↔ 54.5 mm</p>	<p>No. 051</p>  <p>7 min 1 (900) ↓ 112.0 mm ↔ 62.6 mm</p>	<p>No. 058</p>  <p>6 min 1 (900) ↓ 97.1 mm ↔ 65.9 mm</p>
<p>No. 045</p>  <p>3 min 1 (900) ↓ 64.8 mm ↔ 47.3 mm</p>	<p>No. 052</p>  <p>6 min 1 (900) ↓ 103.9 mm ↔ 69.8 mm</p>	<p>No. 059</p>  <p>7 min 1 (900) ↓ 101.4 mm ↔ 64.8 mm</p>
<p>No. 046</p>  <p>4 min 1 (900) ↓ 94.2 mm ↔ 44.9 mm</p>	<p>No. 053</p>  <p>6 min 1 (900) ↓ 96.7 mm ↔ 63.0 mm</p>	<p>No. 060</p>  <p>4 min 1 (900) ↓ 95.8 mm ↔ 57.0 mm</p>
<p>No. 047</p>  <p>5 min 1 (900) ↓ 60.6 mm ↔ 64.5 mm</p>	<p>No. 054</p>  <p>3 min 1 (900) ↓ 95.6 mm ↔ 34.9 mm</p>	

No. 061 **7 min**
 1  (900)
 ↓ 95.8 mm
 ⇔ 63.9 mm

No. 068 **7 min**
 1  (900)
 ↓ 125.5 mm
 ⇔ 63.6 mm

No. 074 **1 min**
 1  (900)
 ↓ 41.5 mm
 ⇔ 17.9 mm

No. 062 **6 min**
 1  (900)
 ↓ 108.7 mm
 ⇔ 62.0 mm

No. 069 **4 min**
 1  (900)
 ↓ 125.3 mm
 ⇔ 42.4 mm

No. 075 **1 min**
 1  (900)
 ↓ 47.9 mm
 ⇔ 19.6 mm

No. 076 **1 min**
 1  (900)
 ↓ 16.4 mm
 ⇔ 22.9 mm

No. 063 **8 min**
 1  (900)
 ↓ 95.5 mm
 ⇔ 74.7 mm

No. 070 **9 min**
 1  (900)
 ↓ 93.9 mm
 ⇔ 81.0 mm

No. 077 **1 min**
 1  (900)
 ↓ 16.4 mm
 ⇔ 11.0 mm

No. 064 **2 min**
 1  (900)
 ↓ 34.2 mm
 ⇔ 33.7 mm

No. 071 **4 min**
 1  (900)
 ↓ 131.7 mm
 ⇔ 59.3 mm

No. 078 **8 min**
 1  (900)
 ↓ 88.5 mm
 ⇔ 160.2 mm

No. 065 **1 min**
 1  (900)
 ↓ 10.8 mm
 ⇔ 10.5 mm

No. 079 **8 min**
 1  (900)
 ↓ 75.6 mm
 ⇔ 161.0 mm

No. 066 **1 min**
 1  (900)
 ↓ 16.5 mm
 ⇔ 11.7 mm

No. 072 **4 min**
 1  (900)
 ↓ 132.0 mm
 ⇔ 59.2 mm

No. 080 **3 min**
 1  (900)
 ↓ 37.1 mm
 ⇔ 123.3 mm

No. 067 **7 min**
 1  (900)
 ↓ 97.4 mm
 ⇔ 74.0 mm

No. 073 **2 min**
 1  (900)
 ↓ 17.7 mm
 ⇔ 65.0 mm

No. 081 **14 min**
 1  (900)
 ↓ 121.1 mm
 ⇔ 189.2 mm

- Vine Alphabet
- Alphabet vignette
- Alfabeto fiorato
- Alfabeto decorativo estilo vinha

- Weinrebenbuchstaben
- Alfabet met wijnrank
- Alfabeto floral
- Шрифт с растительным узором



No. 001

L: 14 min
S: 5 min
1 (620)
2 (612)

L : \updownarrow 108.6 mm
 \leftrightarrow 165.6 mm
 S : \updownarrow 54.3 mm
 \leftrightarrow 82.8 mm

No. 007

L: 11 min
S: 4 min
1 (620)
2 (612)

L : \updownarrow 109.0 mm
 \leftrightarrow 140.6 mm
 S : \updownarrow 54.3 mm
 \leftrightarrow 70.4 mm

No. 013

L: 13 min
S: 4 min
1 (620)
2 (612)

L : \updownarrow 108.3 mm
 \leftrightarrow 170.0 mm
 S : \updownarrow 54.1 mm
 \leftrightarrow 85.0 mm

No. 002

L: 13 min
S: 4 min
1 (620)
2 (612)

L : \updownarrow 108.7 mm
 \leftrightarrow 145.3 mm
 S : \updownarrow 54.4 mm
 \leftrightarrow 72.6 mm

No. 008

L: 14 min
S: 5 min
1 (620)
2 (612)

L : \updownarrow 108.2 mm
 \leftrightarrow 166.8 mm
 S : \updownarrow 54.3 mm
 \leftrightarrow 83.3 mm

No. 014

L: 12 min
S: 4 min
1 (620)
2 (612)

L : \updownarrow 108.9 mm
 \leftrightarrow 169.4 mm
 S : \updownarrow 54.3 mm
 \leftrightarrow 84.8 mm

No. 003

L: 11 min
S: 4 min
1 (620)
2 (612)

L : \updownarrow 107.6 mm
 \leftrightarrow 146.6 mm
 S : \updownarrow 53.9 mm
 \leftrightarrow 73.3 mm

No. 009

L: 9 min
S: 3 min
1 (620)
2 (612)

L : \updownarrow 109.6 mm
 \leftrightarrow 136.2 mm
 S : \updownarrow 55.0 mm
 \leftrightarrow 68.3 mm

No. 015

L: 9 min
S: 3 min
1 (620)
2 (612)

L : \updownarrow 107.7 mm
 \leftrightarrow 157.4 mm
 S : \updownarrow 53.9 mm
 \leftrightarrow 78.7 mm

No. 004

L: 13 min
S: 4 min
1 (620)
2 (612)

L : \updownarrow 109.4 mm
 \leftrightarrow 159.8 mm
 S : \updownarrow 54.6 mm
 \leftrightarrow 80.0 mm

No. 010

L: 11 min
S: 4 min
1 (620)
2 (612)

L : \updownarrow 108.4 mm
 \leftrightarrow 141.9 mm
 S : \updownarrow 54.3 mm
 \leftrightarrow 71.0 mm

No. 016

L: 11 min
S: 4 min
1 (620)
2 (612)

L : \updownarrow 109.3 mm
 \leftrightarrow 134.2 mm
 S : \updownarrow 54.7 mm
 \leftrightarrow 67.2 mm

No. 005

L: 10 min
S: 4 min
1 (620)
2 (612)

L : \updownarrow 109.9 mm
 \leftrightarrow 130.6 mm
 S : \updownarrow 55.0 mm
 \leftrightarrow 65.3 mm

No. 011

L: 13 min
S: 5 min
1 (620)
2 (612)

L : \updownarrow 110.3 mm
 \leftrightarrow 170.2 mm
 S : \updownarrow 55.2 mm
 \leftrightarrow 85.3 mm

No. 017

L: 11 min
S: 4 min
1 (620)
2 (612)

L : \updownarrow 109.8 mm
 \leftrightarrow 167.1 mm
 S : \updownarrow 54.9 mm
 \leftrightarrow 83.5 mm

No. 006

L: 11 min
S: 4 min
1 (620)
2 (612)

L : \updownarrow 107.8 mm
 \leftrightarrow 157.2 mm
 S : \updownarrow 54.0 mm
 \leftrightarrow 78.8 mm

No. 012

L: 11 min
S: 4 min
1 (620)
2 (612)

L : \updownarrow 107.6 mm
 \leftrightarrow 150.0 mm
 S : \updownarrow 53.9 mm
 \leftrightarrow 75.0 mm

No. 018

L: 14 min
S: 5 min
1 (620)
2 (612)

L : \updownarrow 109.3 mm
 \leftrightarrow 163.0 mm
 S : \updownarrow 54.7 mm
 \leftrightarrow 81.5 mm

No. 019

L: 12 min
S: 4 min
1 (620)
2 (612)

L : \updownarrow 108.8 mm
 \leftrightarrow 147.8 mm
 S : \updownarrow 54.5 mm
 \leftrightarrow 73.8 mm



No. 025

L: 10 min
S: 4 min
1 (620)
2 (612)

L : \updownarrow 106.1 mm
 \leftrightarrow 132.1 mm
 S : \updownarrow 53.1 mm
 \leftrightarrow 65.9 mm



No. 020

L: 11 min
S: 4 min
1 (620)
2 (612)

L : \updownarrow 108.3 mm
 \leftrightarrow 146.5 mm
 S : \updownarrow 54.2 mm
 \leftrightarrow 73.2 mm



No. 026

L: 11 min
S: 4 min
1 (620)
2 (612)

L : \updownarrow 111.8 mm
 \leftrightarrow 140.0 mm
 S : \updownarrow 55.9 mm
 \leftrightarrow 70.0 mm



No. 021

L: 12 min
S: 4 min
1 (620)
2 (612)

L : \updownarrow 107.1 mm
 \leftrightarrow 156.8 mm
 S : \updownarrow 53.6 mm
 \leftrightarrow 78.3 mm



No. 027

L: 7 min
S: 3 min
1 (620)
2 (612)

L : \updownarrow 114.6 mm
 \leftrightarrow 115.2 mm
 S : \updownarrow 57.4 mm
 \leftrightarrow 57.7 mm



No. 022

L: 9 min
S: 4 min
1 (620)
2 (612)

L : \updownarrow 106.1 mm
 \leftrightarrow 142.1 mm
 S : \updownarrow 53.2 mm
 \leftrightarrow 70.9 mm



No. 028

L: 8 min
S: 4 min
1 (620)
2 (612)

L : \updownarrow 62.8 mm
 \leftrightarrow 238.6 mm
 S : \updownarrow 31.5 mm
 \leftrightarrow 119.2 mm



No. 023

L: 14 min
S: 5 min
1 (620)
2 (612)

L : \updownarrow 106.7 mm
 \leftrightarrow 165.2 mm
 S : \updownarrow 53.4 mm
 \leftrightarrow 82.6 mm



No. 029

L: 6 min
S: 4 min
1 (620)
2 (612)

L : \updownarrow 24.1 mm
 \leftrightarrow 349.8 mm
 S : \updownarrow 13.4 mm
 \leftrightarrow 195.4 mm



No. 024

L: 12 min
S: 4 min
1 (620)
2 (612)

L : \updownarrow 106.0 mm
 \leftrightarrow 166.6 mm
 S : \updownarrow 53.2 mm
 \leftrightarrow 83.4 mm



No. 030

5 min
1 (612)
2 (620)

\updownarrow 184.8 mm
 \leftrightarrow 56.2 mm



- Line Alphabet
- Alphabet « lignes »
- Alfabeto lineare
- Alfabeto de linhas

- Linienbuchstaben
- Alfabet met belijning
- Alfabeto lineal
- Вензельный шрифт



No. 001

L: 13 min
S: 9 min
1 (005)
2 (807)

L : ↓ 125.1 mm
 ⇔ 103.3 mm
 S : ↓ 95.9 mm
 ⇔ 79.1 mm

No. 006

L: 14 min
S: 10 min
1 (005)
2 (807)

L : ↓ 124.8 mm
 ⇔ 80.6 mm
 S : ↓ 95.8 mm
 ⇔ 61.8 mm

No. 011

L: 14 min
S: 10 min
1 (005)
2 (807)

L : ↓ 125.0 mm
 ⇔ 95.6 mm
 S : ↓ 95.8 mm
 ⇔ 73.4 mm

No. 002

L: 13 min
S: 9 min
1 (005)
2 (807)

L : ↓ 124.8 mm
 ⇔ 86.6 mm
 S : ↓ 95.7 mm
 ⇔ 66.4 mm

No. 007

L: 12 min
S: 9 min
1 (005)
2 (807)

L : ↓ 125.0 mm
 ⇔ 87.6 mm
 S : ↓ 95.8 mm
 ⇔ 67.2 mm

No. 012

L: 13 min
S: 9 min
1 (005)
2 (807)

L : ↓ 124.9 mm
 ⇔ 88.1 mm
 S : ↓ 95.8 mm
 ⇔ 67.6 mm

No. 003

L: 12 min
S: 8 min
1 (005)
2 (807)

L : ↓ 124.8 mm
 ⇔ 85.6 mm
 S : ↓ 95.8 mm
 ⇔ 65.8 mm

No. 008

L: 16 min
S: 11 min
1 (005)
2 (807)

L : ↓ 125.0 mm
 ⇔ 89.8 mm
 S : ↓ 95.7 mm
 ⇔ 68.8 mm

No. 013

L: 20 min
S: 15 min
1 (005)
2 (807)

L : ↓ 125.0 mm
 ⇔ 117.6 mm
 S : ↓ 95.8 mm
 ⇔ 90.4 mm

No. 004

L: 14 min
S: 10 min
1 (005)
2 (807)

L : ↓ 124.8 mm
 ⇔ 95.8 mm
 S : ↓ 95.8 mm
 ⇔ 73.8 mm

No. 009

L: 7 min
S: 5 min
1 (005)
2 (807)

L : ↓ 124.9 mm
 ⇔ 66.0 mm
 S : ↓ 95.8 mm
 ⇔ 50.6 mm

No. 014

L: 15 min
S: 11 min
1 (005)
2 (807)

L : ↓ 124.8 mm
 ⇔ 96.0 mm
 S : ↓ 95.8 mm
 ⇔ 73.6 mm

No. 005

L: 14 min
S: 10 min
1 (005)
2 (807)

L : ↓ 124.8 mm
 ⇔ 87.8 mm
 S : ↓ 95.8 mm
 ⇔ 67.4 mm

No. 010

L: 9 min
S: 7 min
1 (005)
2 (807)

L : ↓ 124.9 mm
 ⇔ 75.4 mm
 S : ↓ 95.8 mm
 ⇔ 57.8 mm

No. 015

L: 14 min
S: 10 min
1 (005)
2 (807)

L : ↓ 124.6 mm
 ⇔ 96.8 mm
 S : ↓ 95.8 mm
 ⇔ 74.4 mm

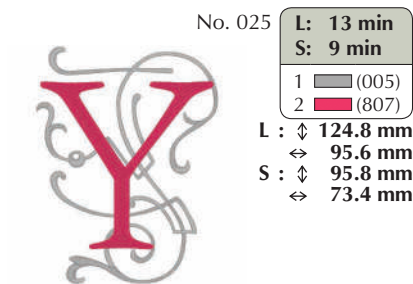
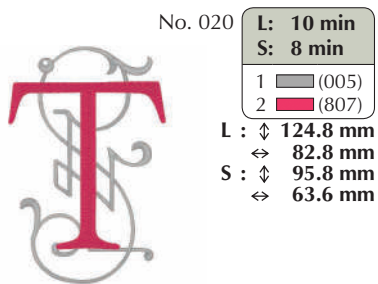
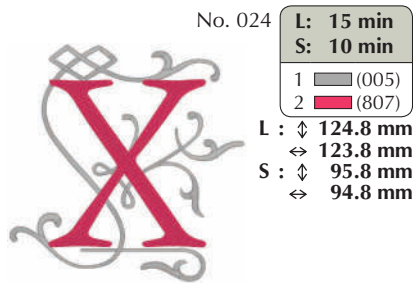
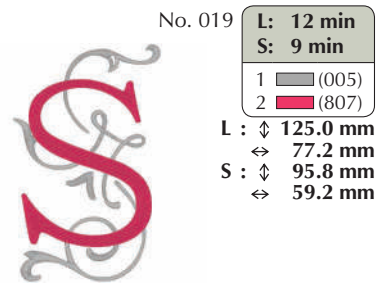
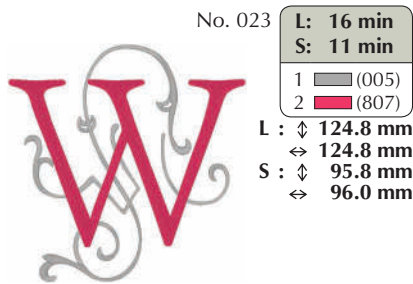
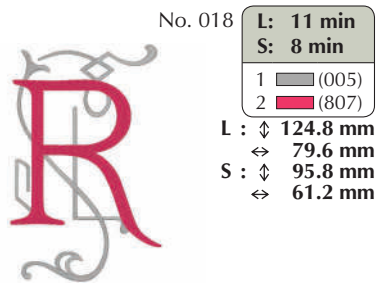
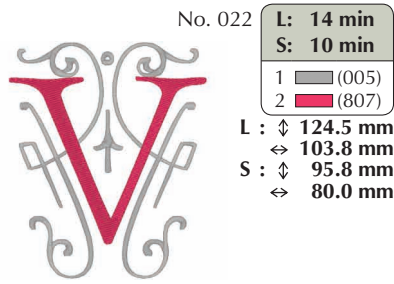
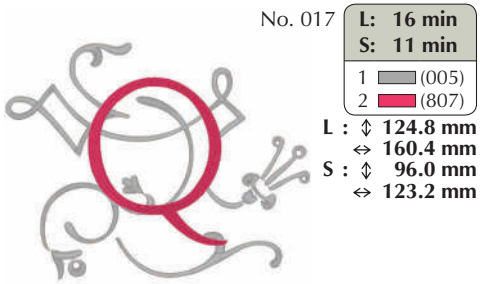
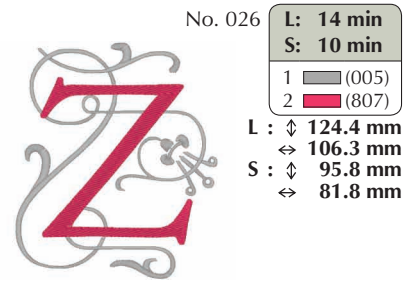
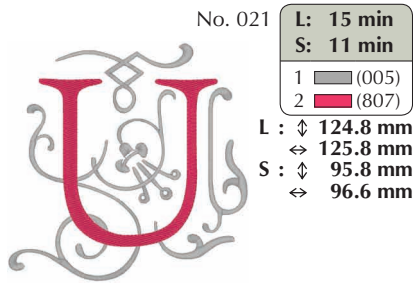
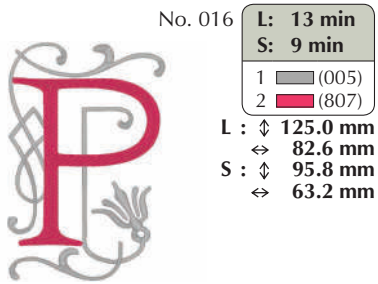

Patterns No.001 - No.026, are designed by Hang to Dry.
 Muster Nr.001 - Nr.026 wurden von Hang to Dry entworfen.
 Les motifs n° 001 à 026 sont conçus par Hang to Dry.
 De ontwerpen 001-026 zijn ontworpen door Hang to Dry.
 I ricami dal N° 001 al N° 026 sono stati ideati da Hang to Dry.
 Los diseños del N°001 al N° 026 están diseñados por Hang to Dry.
 Padrões N° 001 a N° 026 criados por Hang to Dry.
 Авторы дизайнов № 001 - № 026 — дизайнеры компании Hang to Dry.

- Renaissance Alphabet
- Alphabet Renaissance
- Alfabeto rinascimentale
- Alfabeto renascentista

- Renaissancebuchstaben
- Renaissance alfabet
- Alfabético renacentista
- Шрифт "Ренессанс"



No. 001

L: 7 min
S: 5 min
1 (513)
2 (807)
3 (085)
4 (420)
5 (406)

L: \downarrow 49.9 mm
 \leftrightarrow 50.0 mm
 S: \downarrow 33.0 mm
 \leftrightarrow 33.0 mm

No. 006

L: 8 min
S: 6 min
1 (517)
2 (507)
3 (810)
4 (339)
5 (323)

L: \downarrow 49.9 mm
 \leftrightarrow 49.9 mm
 S: \downarrow 32.9 mm
 \leftrightarrow 32.9 mm

No. 011

L: 7 min
S: 5 min
1 (513)
2 (085)
3 (206)
4 (405)
5 (420)

L: \downarrow 50.0 mm
 \leftrightarrow 49.9 mm
 S: \downarrow 32.9 mm
 \leftrightarrow 32.9 mm

No. 002

L: 8 min
S: 5 min
1 (507)
2 (070)
3 (339)
4 (323)

L: \downarrow 50.0 mm
 \leftrightarrow 50.0 mm
 S: \downarrow 33.0 mm
 \leftrightarrow 33.0 mm

No. 007

L: 9 min
S: 7 min
1 (513)
2 (613)
3 (206)
4 (337)
5 (209)

L: \downarrow 50.0 mm
 \leftrightarrow 49.9 mm
 S: \downarrow 32.9 mm
 \leftrightarrow 32.9 mm

No. 012

L: 8 min
S: 6 min
1 (517)
2 (804)
3 (206)
4 (107)
5 (807)

L: \downarrow 50.0 mm
 \leftrightarrow 50.0 mm
 S: \downarrow 33.0 mm
 \leftrightarrow 33.0 mm

No. 003

L: 7 min
S: 5 min
1 (517)
2 (206)
3 (209)
4 (086)
5 (807)

L: \downarrow 49.9 mm
 \leftrightarrow 49.9 mm
 S: \downarrow 32.9 mm
 \leftrightarrow 32.9 mm

No. 008

L: 9 min
S: 6 min
1 (517)
2 (124)
3 (812)
4 (339)
5 (323)

L: \downarrow 49.9 mm
 \leftrightarrow 50.0 mm
 S: \downarrow 33.0 mm
 \leftrightarrow 33.0 mm

No. 013

L: 9 min
S: 6 min
1 (507)
2 (085)
3 (206)
4 (348)
5 (323)

L: \downarrow 49.9 mm
 \leftrightarrow 49.9 mm
 S: \downarrow 33.0 mm
 \leftrightarrow 33.0 mm

No. 004

L: 8 min
S: 5 min
1 (517)
2 (307)
3 (513)
4 (126)
5 (209)

L: \downarrow 50.0 mm
 \leftrightarrow 49.9 mm
 S: \downarrow 33.0 mm
 \leftrightarrow 33.0 mm

No. 009

L: 8 min
S: 6 min
1 (509)
2 (124)
3 (807)
4 (399)
5 (704)

L: \downarrow 49.9 mm
 \leftrightarrow 49.9 mm
 S: \downarrow 32.9 mm
 \leftrightarrow 32.9 mm

No. 014

L: 6 min
S: 4 min
1 (507)
2 (613)
3 (214)
4 (337)

L: \downarrow 49.9 mm
 \leftrightarrow 50.0 mm
 S: \downarrow 33.0 mm
 \leftrightarrow 33.0 mm

No. 005

L: 7 min
S: 5 min
1 (507)
2 (513)
3 (348)
4 (337)

L: \downarrow 49.9 mm
 \leftrightarrow 49.9 mm
 S: \downarrow 32.9 mm
 \leftrightarrow 32.9 mm

No. 010

L: 7 min
S: 5 min
1 (509)
2 (209)
3 (206)
4 (517)
5 (507)

L: \downarrow 50.0 mm
 \leftrightarrow 50.0 mm
 S: \downarrow 32.9 mm
 \leftrightarrow 32.9 mm

No. 015

L: 8 min
S: 6 min
1 (704)
2 (124)
3 (206)
4 (534)
5 (507)

L: \downarrow 49.9 mm
 \leftrightarrow 50.0 mm
 S: \downarrow 33.0 mm
 \leftrightarrow 33.0 mm

No. 016

L: 8 min
S: 5 min

1	(513)
2	(804)
3	(070)
4	(107)
5	(807)

L: \downarrow 50.0 mm
 \leftrightarrow 49.9 mm
S: \downarrow 33.0 mm
 \leftrightarrow 33.0 mm



No. 021

L: 7 min
S: 5 min

1	(534)
2	(804)
3	(810)
4	(085)

L: \downarrow 49.9 mm
 \leftrightarrow 50.0 mm
S: \downarrow 33.0 mm
 \leftrightarrow 33.0 mm



No. 026

L: 6 min
S: 4 min

1	(517)
2	(614)
3	(405)
4	(406)

L: \downarrow 50.0 mm
 \leftrightarrow 50.0 mm
S: \downarrow 32.9 mm
 \leftrightarrow 32.9 mm



No. 017

L: 8 min
S: 5 min

1	(507)
2	(406)
3	(206)
4	(214)

L: \downarrow 49.9 mm
 \leftrightarrow 49.9 mm
S: \downarrow 33.0 mm
 \leftrightarrow 33.0 mm



No. 022

L: 9 min
S: 7 min

1	(513)
2	(406)
3	(001)
4	(513)
5	(337)
6	(209)

L: \downarrow 50.0 mm
 \leftrightarrow 49.9 mm
S: \downarrow 32.9 mm
 \leftrightarrow 32.9 mm



No. 027

2 min

1	(420)
2	(214)
3	(405)

\downarrow 75.0 mm
 \leftrightarrow 79.9 mm



No. 018

L: 11 min
S: 7 min

1	(509)
2	(607)
3	(812)
4	(613)
5	(614)

L: \downarrow 49.9 mm
 \leftrightarrow 49.9 mm
S: \downarrow 32.9 mm
 \leftrightarrow 32.9 mm



No. 023

L: 9 min
S: 6 min

1	(509)
2	(209)
3	(517)
4	(507)

L: \downarrow 50.0 mm
 \leftrightarrow 50.0 mm
S: \downarrow 32.9 mm
 \leftrightarrow 32.9 mm



No. 028

2 min

1	(399)
---	-------

\downarrow 70.0 mm
 \leftrightarrow 49.9 mm



No. 019

L: 6 min
S: 3 min

1	(107)
2	(509)
3	(405)
4	(406)

L: \downarrow 49.9 mm
 \leftrightarrow 49.9 mm
S: \downarrow 32.9 mm
 \leftrightarrow 32.9 mm



No. 024

L: 8 min
S: 6 min

1	(509)
2	(812)
3	(126)
4	(804)
5	(613)

L: \downarrow 49.9 mm
 \leftrightarrow 50.0 mm
S: \downarrow 32.9 mm
 \leftrightarrow 33.0 mm



No. 029

3 min

1	(420)
2	(214)
3	(405)
4	(399)

\downarrow 96.0 mm
 \leftrightarrow 52.9 mm



No. 020

L: 8 min
S: 6 min

1	(513)
2	(420)
3	(206)
4	(126)
5	(209)

L: \downarrow 49.9 mm
 \leftrightarrow 50.0 mm
S: \downarrow 33.0 mm
 \leftrightarrow 33.0 mm



No. 025

L: 7 min
S: 4 min

1	(513)
2	(206)
3	(405)
4	(420)

L: \downarrow 49.9 mm
 \leftrightarrow 49.9 mm
S: \downarrow 32.9 mm
 \leftrightarrow 32.9 mm





- Vintage Alphabet
- Alphabet vintage (rétro)
- Alfabeto vintage
- Alfabeto vintage

- Vintage Buchstaben
- Alfabet in retrostijl
- Alfabeto antiguo
- Винтажный шрифт





No. 001 **18 min**
 1  (323)
 ↓ 148.0 mm
 ↔ 129.6 mm





No. 007 **19 min**
 1  (323)
 ↓ 150.4 mm
 ↔ 111.7 mm





No. 013 **29 min**
 1  (323)
 ↓ 149.2 mm
 ↔ 150.1 mm



No. 002 **20 min**
 1  (323)
 ↓ 149.9 mm
 ↔ 110.9 mm





No. 008 **22 min**
 1  (323)
 ↓ 149.1 mm
 ↔ 125.6 mm





No. 014 **22 min**
 1  (323)
 ↓ 149.7 mm
 ↔ 131.1 mm





No. 003 **15 min**
 1  (323)
 ↓ 152.9 mm
 ↔ 102.3 mm





No. 009 **10 min**
 1  (323)
 ↓ 149.1 mm
 ↔ 58.0 mm





No. 015 **20 min**
 1  (323)
 ↓ 151.7 mm
 ↔ 107.1 mm





No. 004 **19 min**
 1  (323)
 ↓ 149.3 mm
 ↔ 111.7 mm





No. 010 **12 min**
 1  (323)
 ↓ 148.8 mm
 ↔ 93.9 mm





No. 016 **17 min**
 1  (323)
 ↓ 149.4 mm
 ↔ 111.7 mm





No. 005 **20 min**
 1  (323)
 ↓ 149.1 mm
 ↔ 109.7 mm





No. 011 **21 min**
 1  (323)
 ↓ 149.4 mm
 ↔ 125.1 mm





No. 017 **19 min**
 1  (323)
 ↓ 149.6 mm
 ↔ 108.3 mm





No. 006 **16 min**
 1  (323)
 ↓ 149.3 mm
 ↔ 107.4 mm



No. 012 **14 min**
 1  (323)
 ↓ 149.2 mm
 ↔ 107.1 mm



No. 018 **21 min**
 1  (323)
 ↓ 149.5 mm
 ↔ 123.2 mm



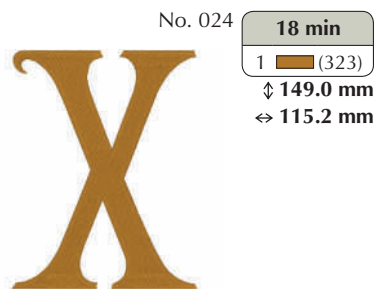
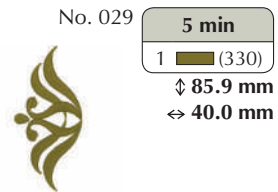
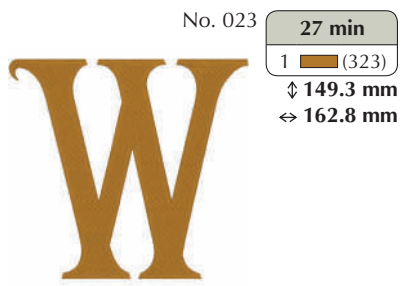
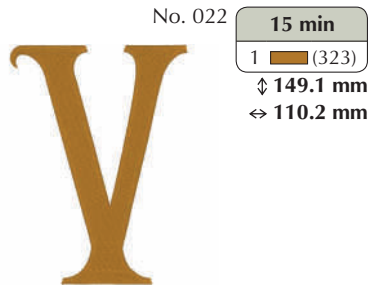
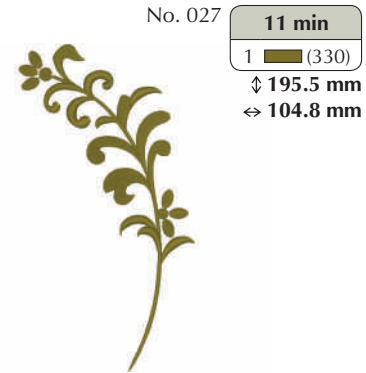
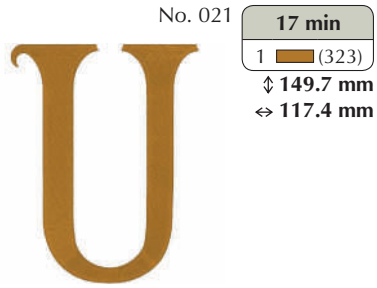
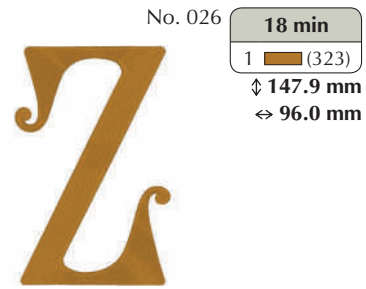
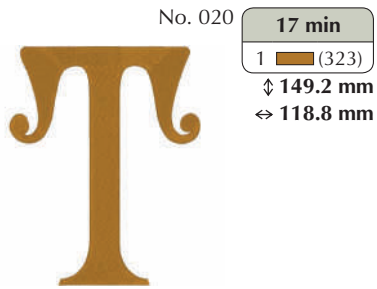
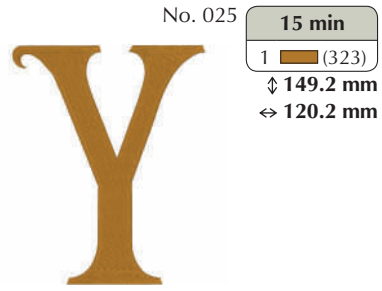
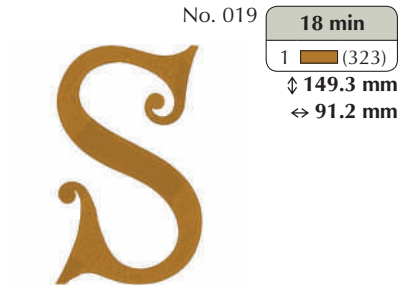

- Appliqué Alphabet
- Alphabet appliqué
- Alfabeto in applique
- Alfabeto para apliques

- Buchstabenapplikationen
- Blokletter applicatie alfabet
- Diseños alfabeticos con adornos
- Шрифт для аппликации

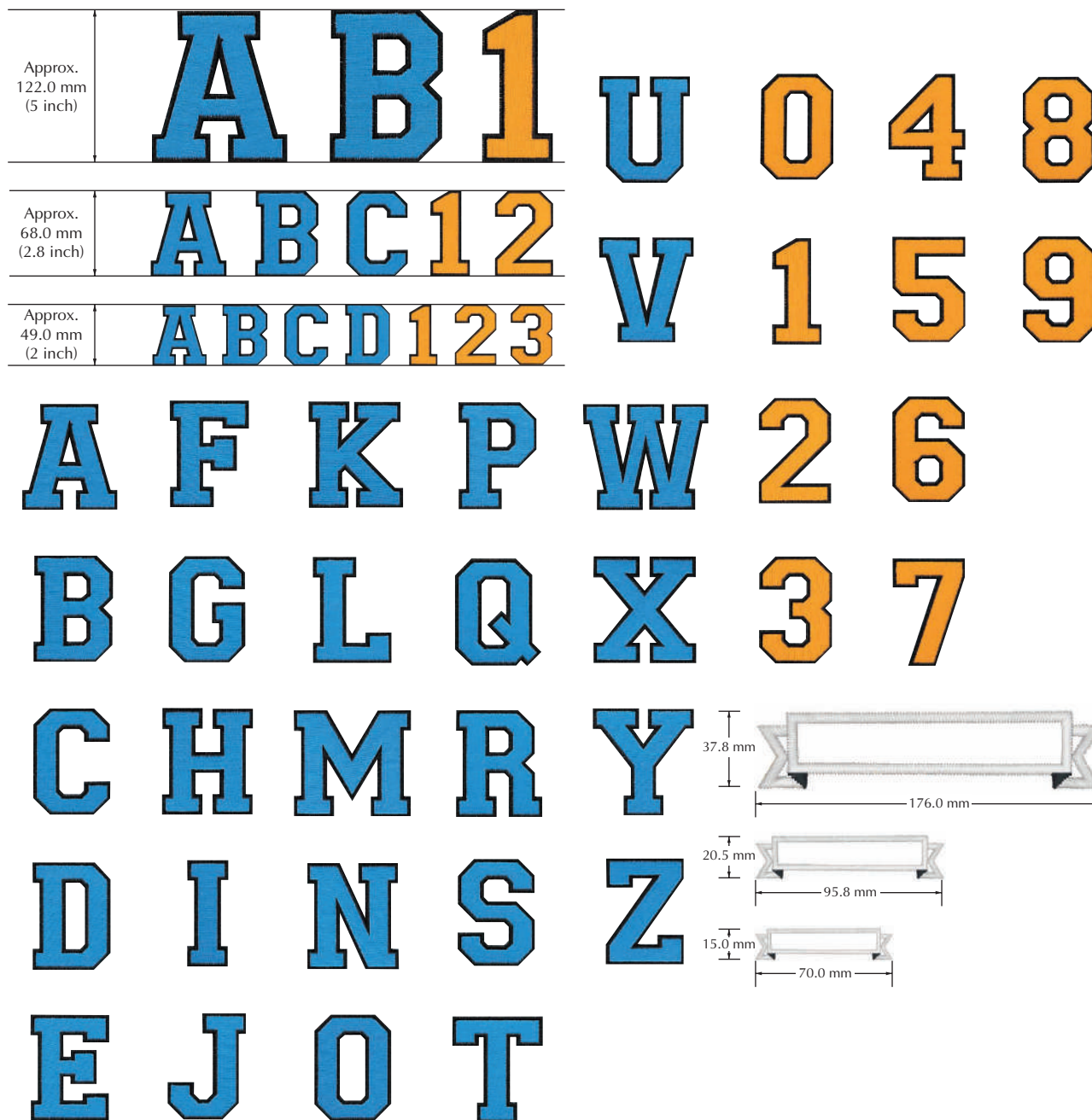

- ★ Refer to the operation manual for the embroidery machine for details on how to embroider appliqués.
- ★ Weitere Hinweise zum Sticken von Applikationen finden Sie in der Bedienungsanleitung der Stickmaschine.
- ★ Reportez-vous au manuel d'instructions de la machine à broder pour plus d'informations sur la broderie des appliqués.
- ★ Raadpleeg de bedieningshandleiding bij de borduurmachine voor gedetailleerde uitleg over het borduren van applicaties.
- ★ Consultare il manuale di istruzioni della macchina per ricamare per i dettagli relativi al ricamo in appliqué.
- ★ Consulte el manual de instrucciones de la máquina de bordar si desea más información sobre cómo bordar apliques.
- ★ Consulte o manual de operações da máquina de bordar para obter detalhes sobre como bordar apliques.
- ★ Инструкции по вышиванию аппликаций приведены в руководстве пользователя машины.

- Block Alphabet
- Alphabet en bloc
- Alfabeto a blocchi
- Alfabeto sólido

- Blockbuchstaben
- Blokletter alfabet
- Alfabeto sólido
- Рубленный шрифт



No. 001

38 min	
1	█ (509)
2	▢ (001)
3	■ (900)
↓ 152.3 mm	
↔ 111.6 mm	



No. 007

41 min	
1	█ (509)
2	▢ (001)
3	■ (900)
↓ 152.3 mm	
↔ 103.1 mm	



No. 013

54 min	
1	█ (509)
2	▢ (001)
3	■ (900)
↓ 152.3 mm	
↔ 124.8 mm	



No. 002

44 min	
1	█ (509)
2	▢ (001)
3	■ (900)
↓ 152.3 mm	
↔ 103.1 mm	



No. 008

40 min	
1	█ (509)
2	▢ (001)
3	■ (900)
↓ 152.3 mm	
↔ 103.1 mm	



No. 014

45 min	
1	█ (509)
2	▢ (001)
3	■ (900)
↓ 152.3 mm	
↔ 103.1 mm	



No. 003

35 min	
1	█ (509)
2	▢ (001)
3	■ (900)
↓ 152.3 mm	
↔ 103.1 mm	



No. 009

20 min	
1	█ (509)
2	▢ (001)
3	■ (900)
↓ 152.3 mm	
↔ 39.0 mm	



No. 015

40 min	
1	█ (509)
2	▢ (001)
3	■ (900)
↓ 152.3 mm	
↔ 103.1 mm	



No. 004

41 min	
1	█ (509)
2	▢ (001)
3	■ (900)
↓ 152.3 mm	
↔ 103.1 mm	



No. 010

28 min	
1	█ (509)
2	▢ (001)
3	■ (900)
↓ 152.3 mm	
↔ 103.5 mm	



No. 016

35 min	
1	█ (509)
2	▢ (001)
3	■ (900)
↓ 152.3 mm	
↔ 103.1 mm	



No. 005

34 min	
1	█ (509)
2	▢ (001)
3	■ (900)
↓ 152.3 mm	
↔ 90.8 mm	



No. 011

39 min	
1	█ (509)
2	▢ (001)
3	■ (900)
↓ 152.3 mm	
↔ 107.3 mm	



No. 017

41 min	
1	█ (509)
2	▢ (001)
3	■ (900)
↓ 152.3 mm	
↔ 109.2 mm	



No. 006

29 min	
1	█ (509)
2	▢ (001)
3	■ (900)
↓ 152.3 mm	
↔ 90.8 mm	



No. 012

24 min	
1	█ (509)
2	▢ (001)
3	■ (900)
↓ 152.3 mm	
↔ 90.8 mm	



No. 018

42 min	
1	█ (509)
2	▢ (001)
3	■ (900)
↓ 152.3 mm	
↔ 103.1 mm	

	<p>No. 019</p> <p>39 min</p> <p>1  (509) 2  (001) 3  (900)</p> <p>↓ 152.3 mm ↔ 103.5 mm</p>		<p>No. 026</p> <p>32 min</p> <p>1  (509) 2  (001) 3  (900)</p> <p>↓ 152.3 mm ↔ 96.9 mm</p>		<p>No. 033</p> <p>36 min</p> <p>1  (509) 2  (001) 3  (900)</p> <p>↓ 148.5 mm ↔ 85.8 mm</p>
	<p>No. 020</p> <p>26 min</p> <p>1  (509) 2  (001) 3  (900)</p> <p>↓ 152.3 mm ↔ 103.9 mm</p>		<p>No. 027</p> <p>28 min</p> <p>1  (509) 2  (001) 3  (900)</p> <p>↓ 106.7 mm ↔ 86.3 mm</p>		<p>No. 034</p> <p>31 min</p> <p>1  (509) 2  (001) 3  (900)</p> <p>↓ 152.3 mm ↔ 85.8 mm</p>
	<p>No. 021</p> <p>39 min</p> <p>1  (509) 2  (001) 3  (900)</p> <p>↓ 152.3 mm ↔ 103.1 mm</p>		<p>No. 028</p> <p>32 min</p> <p>1  (509) 2  (001) 3  (900)</p> <p>↓ 152.3 mm ↔ 85.8 mm</p>		<p>No. 035</p> <p>18 min</p> <p>1  (509) 2  (001) 3  (900)</p> <p>↓ 152.3 mm ↔ 33.7 mm</p>
	<p>No. 022</p> <p>36 min</p> <p>1  (509) 2  (001) 3  (900)</p> <p>↓ 152.3 mm ↔ 111.6 mm</p>		<p>No. 029</p> <p>24 min</p> <p>1  (509) 2  (001) 3  (900)</p> <p>↓ 106.7 mm ↔ 85.8 mm</p>		<p>No. 036</p> <p>23 min</p> <p>1  (509) 2  (001) 3  (900)</p> <p>↓ 194.1 mm ↔ 48.5 mm</p>
	<p>No. 023</p> <p>55 min</p> <p>1  (509) 2  (001) 3  (900)</p> <p>↓ 152.3 mm ↔ 141.4 mm</p>		<p>No. 030</p> <p>32 min</p> <p>1  (509) 2  (001) 3  (900)</p> <p>↓ 152.3 mm ↔ 85.8 mm</p>		<p>No. 037</p> <p>31 min</p> <p>1  (509) 2  (001) 3  (900)</p> <p>↓ 152.3 mm ↔ 88.5 mm</p>
	<p>No. 024</p> <p>34 min</p> <p>1  (509) 2  (001) 3  (900)</p> <p>↓ 152.3 mm ↔ 103.9 mm</p>		<p>No. 031</p> <p>27 min</p> <p>1  (509) 2  (001) 3  (900)</p> <p>↓ 106.7 mm ↔ 85.8 mm</p>		<p>No. 038</p> <p>18 min</p> <p>1  (509) 2  (001) 3  (900)</p> <p>↓ 152.3 mm ↔ 33.7 mm</p>
	<p>No. 025</p> <p>29 min</p> <p>1  (509) 2  (001) 3  (900)</p> <p>↓ 152.3 mm ↔ 112.7 mm</p>		<p>No. 032</p> <p>21 min</p> <p>1  (509) 2  (001) 3  (900)</p> <p>↓ 152.3 mm ↔ 63.2 mm</p>		<p>No. 038</p> <p>18 min</p> <p>1  (509) 2  (001) 3  (900)</p> <p>↓ 152.3 mm ↔ 33.7 mm</p>



No. 039

38 min

1	■ (509)
2	□ (001)
3	■ (900)

↓ 106.7 mm
↔ 124.8 mm



No. 046

21 min

1	■ (509)
2	□ (001)
3	■ (900)

↓ 140.0 mm
↔ 67.8 mm



No. 053

39 min

1	■ (509)
2	□ (001)
3	■ (900)

↓ 152.3 mm
↔ 98.9 mm



No. 040

26 min

1	■ (509)
2	□ (001)
3	■ (900)

↓ 106.7 mm
↔ 85.8 mm



No. 047

26 min

1	■ (509)
2	□ (001)
3	■ (900)

↓ 106.7 mm
↔ 85.8 mm



No. 054

21 min

1	■ (509)
2	□ (001)
3	■ (900)

↓ 152.3 mm
↔ 56.7 mm



No. 041

26 min

1	■ (509)
2	□ (001)
3	■ (900)

↓ 106.7 mm
↔ 85.8 mm



No. 048

23 min

1	■ (509)
2	□ (001)
3	■ (900)

↓ 106.7 mm
↔ 93.8 mm



No. 055

35 min

1	■ (509)
2	□ (001)
3	■ (900)

↓ 152.3 mm
↔ 98.9 mm



No. 042

31 min

1	■ (509)
2	□ (001)
3	■ (900)

↓ 148.5 mm
↔ 85.8 mm



No. 049

38 min

1	■ (509)
2	□ (001)
3	■ (900)

↓ 106.7 mm
↔ 143.1 mm



No. 056

36 min

1	■ (509)
2	□ (001)
3	■ (900)

↓ 152.3 mm
↔ 98.9 mm



No. 043

31 min

1	■ (509)
2	□ (001)
3	■ (900)

↓ 148.5 mm
↔ 85.8 mm



No. 050

22 min

1	■ (509)
2	□ (001)
3	■ (900)

↓ 106.7 mm
↔ 88.8 mm



No. 057

35 min

1	■ (509)
2	□ (001)
3	■ (900)

↓ 152.3 mm
↔ 105.5 mm



No. 044

15 min

1	■ (509)
2	□ (001)
3	■ (900)

↓ 106.7 mm
↔ 58.7 mm



No. 051

26 min

1	■ (509)
2	□ (001)
3	■ (900)

↓ 148.5 mm
↔ 94.1 mm



No. 058

35 min

1	■ (509)
2	□ (001)
3	■ (900)

↓ 152.3 mm
↔ 98.9 mm



No. 045

26 min

1	■ (509)
2	□ (001)
3	■ (900)

↓ 106.7 mm
↔ 83.8 mm



No. 052

21 min

1	■ (509)
2	□ (001)
3	■ (900)

↓ 106.7 mm
↔ 75.2 mm























No. 059

40 min

1	■ (509)
2	□ (001)
3	■ (900)

↓ 152.3 mm
↔ 98.9 mm

	<p>No. 060</p> <p>26 min</p> <p>1 (509) 2 (001) 3 (900)</p> <p>↓ 152.3 mm ↔ 98.9 mm</p>		<p>No. 067</p> <p>38 min</p> <p>1 (509) 2 (001) 3 (900)</p> <p>↓ 152.3 mm ↔ 106.3 mm</p>		<p>No. 076</p> <p>8 min</p> <p>1 (509) 2 (001) 3 (900)</p> <p>↓ 53.9 mm ↔ 46.6 mm</p>
	<p>No. 061</p> <p>41 min</p> <p>1 (509) 2 (001) 3 (900)</p> <p>↓ 152.3 mm ↔ 98.9 mm</p>		<p>No. 068</p> <p>35 min</p> <p>1 (509) 2 (001) 3 (900)</p> <p>↓ 152.3 mm ↔ 105.7 mm</p>		<p>No. 077</p> <p>44 min</p> <p>1 (509) 2 (001) 3 (900)</p> <p>↓ 152.3 mm ↔ 136.9 mm</p>
	<p>No. 062</p> <p>40 min</p> <p>1 (509) 2 (001) 3 (900)</p> <p>↓ 152.3 mm ↔ 98.9 mm</p>		<p>No. 069</p> <p>6 min</p> <p>1 (509) 2 (001) 3 (900)</p> <p>↓ 25.5 mm ↔ 55.0 mm</p>		<p>No. 078</p> <p>30 min</p> <p>1 (509) 2 (001) 3 (900)</p> <p>↓ 152.3 mm ↔ 103.1 mm</p>
	<p>No. 063</p> <p>39 min</p> <p>1 (509) 2 (001) 3 (900)</p> <p>↓ 152.3 mm ↔ 117.7 mm</p>		<p>No. 070</p> <p>15 min</p> <p>1 (509) 2 (001) 3 (900)</p> <p>↓ 92.8 mm ↔ 92.8 mm</p>		<p>No. 079</p> <p>21 min</p> <p>1 (509) 2 (001) 3 (900)</p> <p>↓ 152.3 mm ↔ 41.1 mm</p>
	<p>No. 064</p> <p>50 min</p> <p>1 (509) 2 (001) 3 (900)</p> <p>↓ 152.3 mm ↔ 144.9 mm</p>		<p>No. 071</p> <p>16 min</p> <p>1 (509) 2 (001) 3 (900)</p> <p>↓ 88.0 mm ↔ 87.6 mm</p>		<p>No. 080</p> <p>56 min</p> <p>1 (509) 2 (001) 3 (900)</p> <p>↓ 152.3 mm ↔ 137.5 mm</p>
	<p>No. 065</p> <p>41 min</p> <p>1 (509) 2 (001) 3 (900)</p> <p>↓ 182.6 mm ↔ 98.9 mm</p>		<p>No. 073</p> <p>19 min</p> <p>1 (509) 2 (001) 3 (900)</p> <p>↓ 60.8 mm ↔ 92.8 mm</p>		<p>No. 081</p> <p>15 min</p> <p>1 (509) 2 (001) 3 (900)</p> <p>↓ 108.2 mm ↔ 71.0 mm</p>
	<p>No. 066</p> <p>36 min</p> <p>1 (509) 2 (001) 3 (900)</p> <p>↓ 152.3 mm ↔ 101.0 mm</p>		<p>No. 074</p> <p>18 min</p> <p>1 (509) 2 (001) 3 (900)</p> <p>↓ 81.8 mm ↔ 83.3 mm</p>		<p>No. 082</p> <p>15 min</p> <p>1 (509) 2 (001) 3 (900)</p> <p>↓ 108.3 mm ↔ 71.1 mm</p>

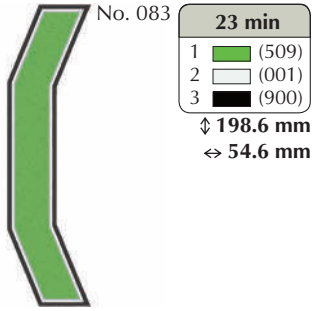

No. 083

23 min	
1	■ (509)
2	□ (001)
3	■ (900)
↓ 198.6 mm	
↔ 54.6 mm	

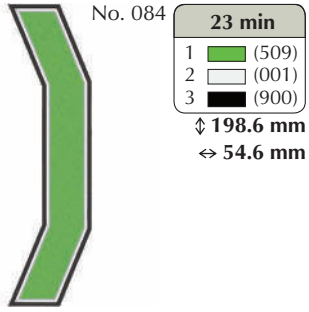

No. 084

23 min	
1	■ (509)
2	□ (001)
3	■ (900)
↓ 198.6 mm	
↔ 54.6 mm	

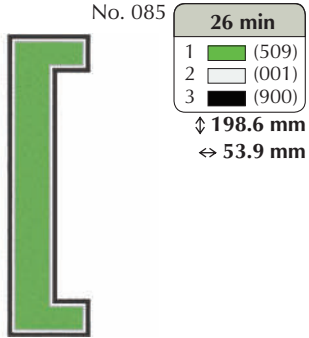

No. 085

26 min	
1	■ (509)
2	□ (001)
3	■ (900)
↓ 198.6 mm	
↔ 53.9 mm	

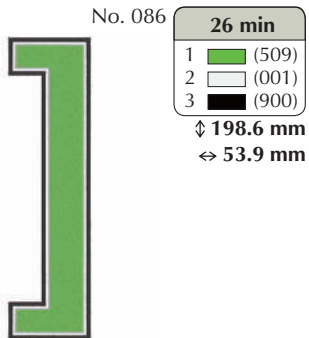

No. 086

26 min	
1	■ (509)
2	□ (001)
3	■ (900)
↓ 198.6 mm	
↔ 53.9 mm	

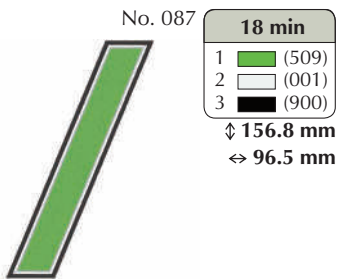

No. 087

18 min	
1	■ (509)
2	□ (001)
3	■ (900)
↓ 156.8 mm	
↔ 96.5 mm	

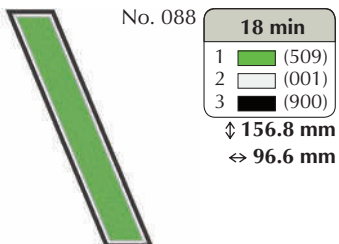

No. 088

18 min	
1	■ (509)
2	□ (001)
3	■ (900)
↓ 156.8 mm	
↔ 96.6 mm	



No. 089

12 min	
1	■ (509)
2	□ (001)
3	■ (900)
↓ 52.1 mm	
↔ 106.9 mm	

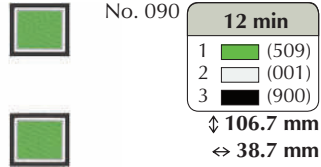

No. 090

12 min	
1	■ (509)
2	□ (001)
3	■ (900)
↓ 106.7 mm	
↔ 38.7 mm	

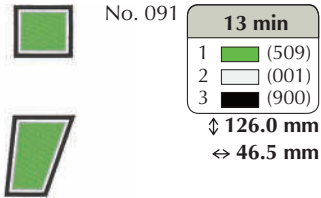

No. 091

13 min	
1	■ (509)
2	□ (001)
3	■ (900)
↓ 126.0 mm	
↔ 46.5 mm	

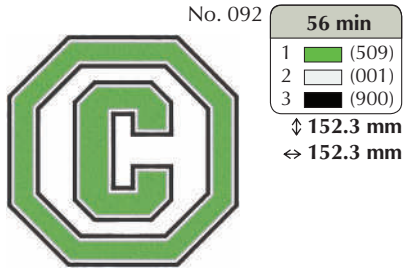

No. 092

56 min	
1	■ (509)
2	□ (001)
3	■ (900)
↓ 152.3 mm	
↔ 152.3 mm	

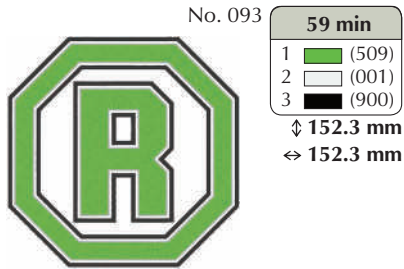

No. 093

59 min	
1	■ (509)
2	□ (001)
3	■ (900)
↓ 152.3 mm	
↔ 152.3 mm	

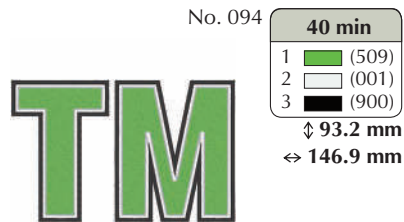

No. 094

40 min	
1	■ (509)
2	□ (001)
3	■ (900)
↓ 93.2 mm	
↔ 146.9 mm	



No. 095

15 min	
1	■ (509)
2	□ (001)
3	■ (900)
↓ 53.5 mm	
↔ 89.9 mm	

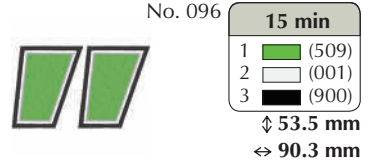

No. 096

15 min	
1	■ (509)
2	□ (001)
3	■ (900)
↓ 53.5 mm	
↔ 90.3 mm	

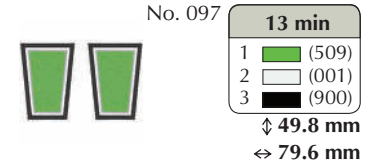

No. 097

13 min	
1	■ (509)
2	□ (001)
3	■ (900)
↓ 49.8 mm	
↔ 79.6 mm	

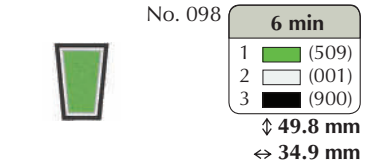

No. 098

6 min	
1	■ (509)
2	□ (001)
3	■ (900)
↓ 49.8 mm	
↔ 34.9 mm	

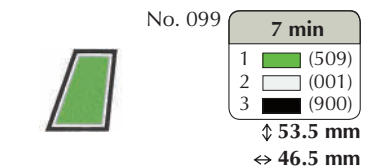

No. 099

7 min	
1	■ (509)
2	□ (001)
3	■ (900)
↓ 53.5 mm	
↔ 46.5 mm	

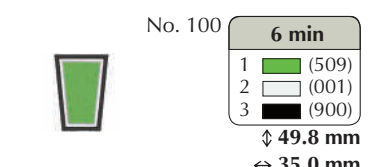

No. 100

6 min	
1	■ (509)
2	□ (001)
3	■ (900)
↓ 49.8 mm	
↔ 35.0 mm	

- Striped Alphabet
- Alphabet rayé
- Alfabeto a strisce
- Alfabeto listrado

- Gestreifte Buchstaben
- Gestreept alfabet
- Alfabeto rayado
- Шрифт "Полоска"

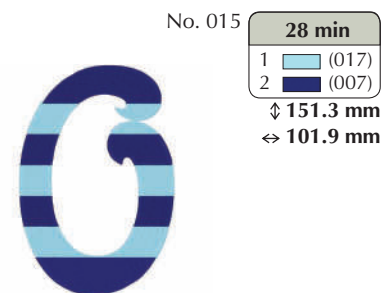
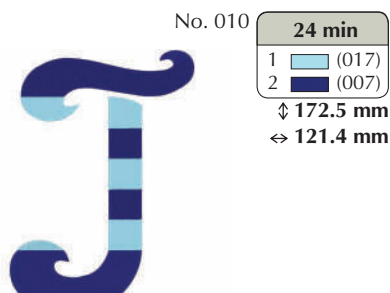
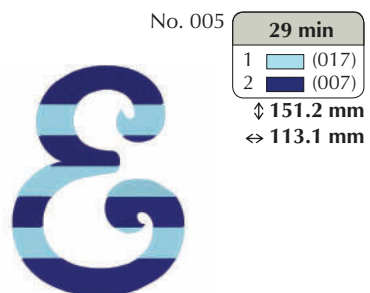
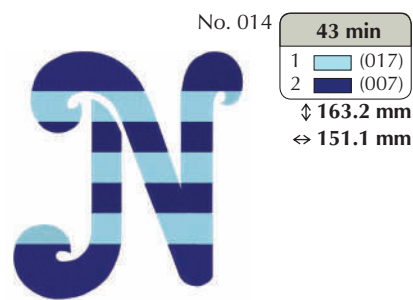
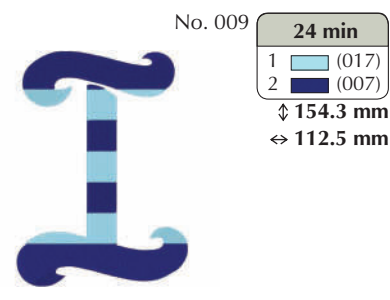
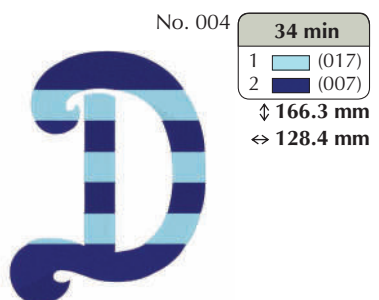
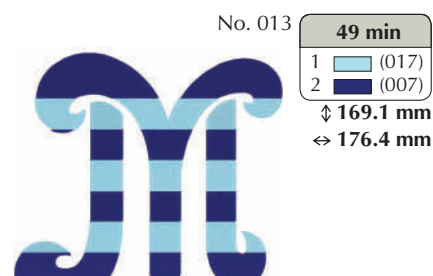
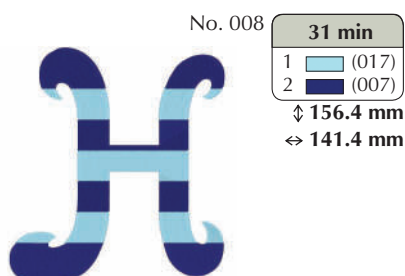
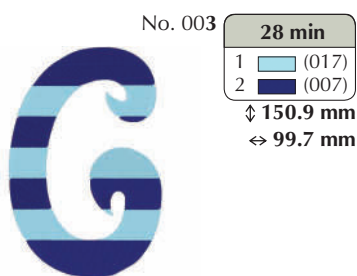
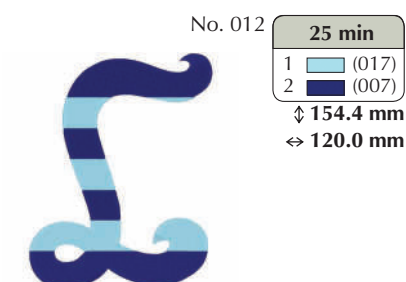
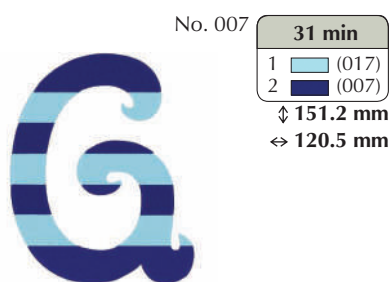
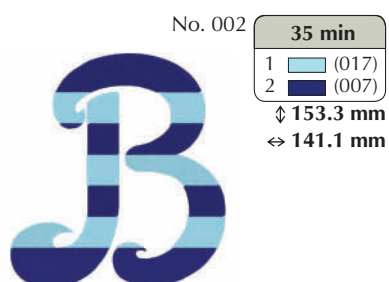
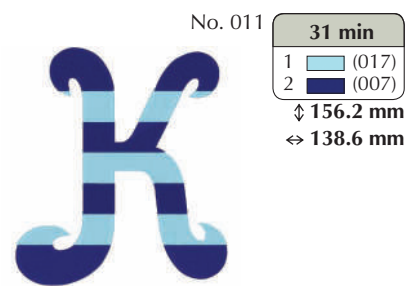
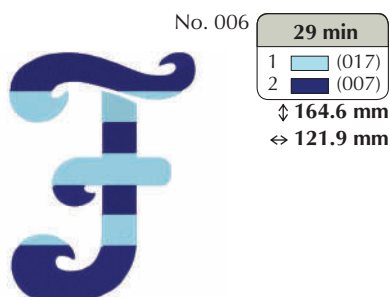
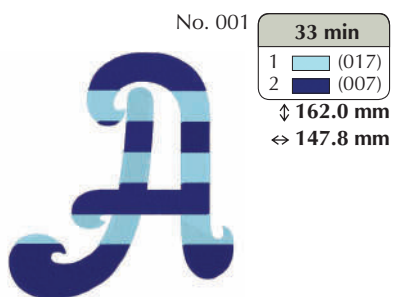



No. 016

32 min	
1	(017)
2	(007)
↓ 171.8 mm	
↔ 132.3 mm	



No. 022

27 min	
1	(017)
2	(007)
↓ 158.5 mm	
↔ 115.1 mm	



No. 028

24 min	
1	(017)
2	(007)
↓ 147.2 mm	
↔ 102.0 mm	



No. 017

32 min	
1	(017)
2	(007)
↓ 165.5 mm	
↔ 117.5 mm	



No. 023

42 min	
1	(017)
2	(007)
↓ 152.7 mm	
↔ 163.8 mm	



No. 029

16 min	
1	(017)
2	(007)
↓ 107.6 mm	
↔ 73.9 mm	



No. 018

34 min	
1	(017)
2	(007)
↓ 163.7 mm	
↔ 127.9 mm	



No. 024

29 min	
1	(017)
2	(007)
↓ 149.5 mm	
↔ 137.7 mm	



No. 030

24 min	
1	(017)
2	(007)
↓ 149.3 mm	
↔ 100.6 mm	



No. 019

33 min	
1	(017)
2	(007)
↓ 157.0 mm	
↔ 113.1 mm	



No. 025

29 min	
1	(017)
2	(007)
↓ 161.8 mm	
↔ 116.4 mm	



No. 031

18 min	
1	(017)
2	(007)
↓ 107.2 mm	
↔ 74.0 mm	



No. 020

22 min	
1	(017)
2	(007)
↓ 162.3 mm	
↔ 126.8 mm	



No. 026

27 min	
1	(017)
2	(007)
↓ 153.1 mm	
↔ 120.4 mm	



No. 032

20 min	
1	(017)
2	(007)
↓ 176.4 mm	
↔ 89.2 mm	



No. 021

29 min	
1	(017)
2	(007)
↓ 151.3 mm	
↔ 123.4 mm	



No. 027

18 min	
1	(017)
2	(007)
↓ 105.0 mm	
↔ 87.9 mm	



No. 033

23 min	
1	(017)
2	(007)
↓ 139.1 mm	
↔ 94.3 mm	



No. 034

25 min	
1	Light Blue (017)
2	Dark Blue (007)
↓ 148.8 mm	
↔ 113.4 mm	



No. 040

20 min	
1	Light Blue (017)
2	Dark Blue (007)
↓ 106.2 mm	
↔ 105.2 mm	



No. 046

18 min	
1	Light Blue (017)
2	Dark Blue (007)
↓ 140.8 mm	
↔ 81.9 mm	



No. 035

14 min	
1	Light Blue (017)
2	Dark Blue (007)
↓ 140.7 mm	
↔ 63.5 mm	



No. 041

17 min	
1	Light Blue (017)
2	Dark Blue (007)
↓ 108.3 mm	
↔ 71.4 mm	



No. 047

20 min	
1	Light Blue (017)
2	Dark Blue (007)
↓ 108.1 mm	
↔ 106.2 mm	



No. 036

17 min	
1	Light Blue (017)
2	Dark Blue (007)
↓ 174.9 mm	
↔ 61.6 mm	



No. 042

22 min	
1	Light Blue (017)
2	Dark Blue (007)
↓ 139.5 mm	
↔ 103.8 mm	



No. 048

17 min	
1	Light Blue (017)
2	Dark Blue (007)
↓ 106.9 mm	
↔ 98.3 mm	



No. 037

26 min	
1	Light Blue (017)
2	Dark Blue (007)
↓ 150.9 mm	
↔ 116.9 mm	



No. 043

21 min	
1	Light Blue (017)
2	Dark Blue (007)
↓ 138.0 mm	
↔ 94.8 mm	



No. 049

26 min	
1	Light Blue (017)
2	Dark Blue (007)
↓ 105.0 mm	
↔ 131.7 mm	



No. 038

17 min	
1	Light Blue (017)
2	Dark Blue (007)
↓ 152.6 mm	
↔ 69.4 mm	



No. 044

13 min	
1	Light Blue (017)
2	Dark Blue (007)
↓ 106.2 mm	
↔ 78.2 mm	



No. 050

18 min	
1	Light Blue (017)
2	Dark Blue (007)
↓ 102.6 mm	
↔ 102.6 mm	



No. 039

29 min	
1	Light Blue (017)
2	Dark Blue (007)
↓ 109.3 mm	
↔ 149.5 mm	



No. 045

18 min	
1	Light Blue (017)
2	Dark Blue (007)
↓ 107.1 mm	
↔ 87.7 mm	





No. 051

24 min	
1	Light Blue (017)
2	Dark Blue (007)
↓ 135.6 mm	
↔ 86.0 mm	

No. 052 **16 min**





1  (017)
2  (007)

↓ 104.7 mm
↔ 90.2 mm

No. 058 **31 min**





1  (017)
2  (007)

↓ 157.5 mm
↔ 100.7 mm

No. 064 **41 min**





1  (017)
2  (007)

↓ 154.0 mm
↔ 137.1 mm

No. 053 **25 min**





1  (017)
2  (007)

↓ 151.0 mm
↔ 96.6 mm

No. 059 **30 min**





1  (017)
2  (007)

↓ 151.3 mm
↔ 94.4 mm

No. 065 **32 min**





1  (017)
2  (007)

↓ 164.2 mm
↔ 100.3 mm

No. 054 **16 min**





1  (017)
2  (007)

↓ 155.5 mm
↔ 58.7 mm

No. 060 **21 min**





1  (017)
2  (007)

↓ 151.3 mm
↔ 103.4 mm

No. 066 **29 min**





1  (017)
2  (007)

↓ 153.3 mm
↔ 126.4 mm

No. 055 **25 min**





1  (017)
2  (007)

↓ 148.7 mm
↔ 103.0 mm

No. 061 **27 min**





1  (017)
2  (007)

↓ 153.1 mm
↔ 96.5 mm

No. 067 **34 min**





1  (017)
2  (007)

↓ 150.5 mm
↔ 129.0 mm

No. 056 **27 min**





1  (017)
2  (007)

↓ 151.6 mm
↔ 102.8 mm

No. 062 **27 min**





1  (017)
2  (007)

↓ 152.0 mm
↔ 92.7 mm

No. 068 **26 min**





1  (017)
2  (007)

↓ 157.6 mm
↔ 100.5 mm

No. 057 **28 min**





1  (017)
2  (007)

↓ 152.5 mm
↔ 109.7 mm

No. 063 **37 min**





1  (017)
2  (007)

↓ 162.5 mm
↔ 142.0 mm

No. 069 **4 min**



1  (017)
2  (007)

↓ 25.4 mm
↔ 52.4 mm

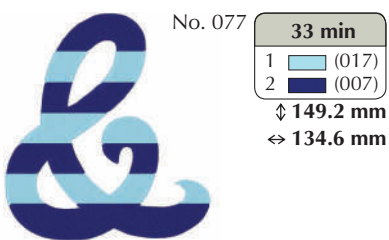
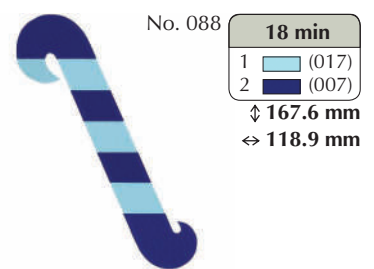
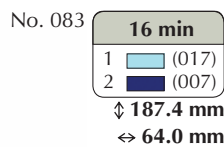
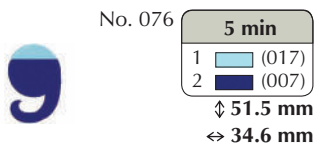
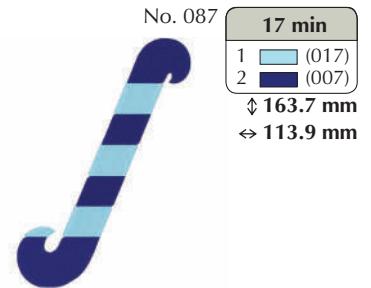
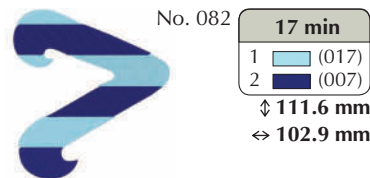
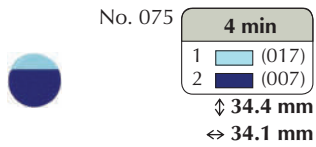
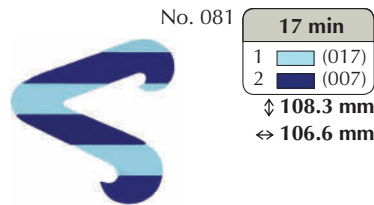
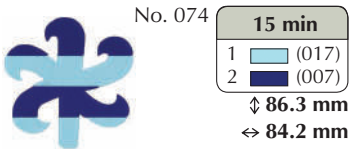
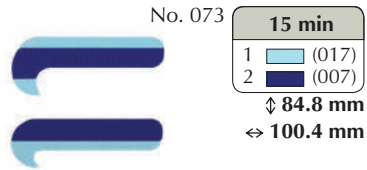
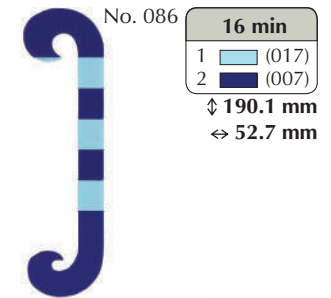
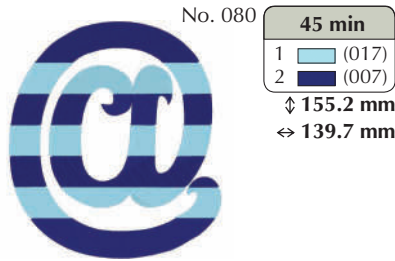
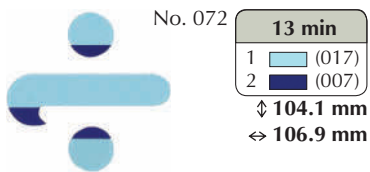
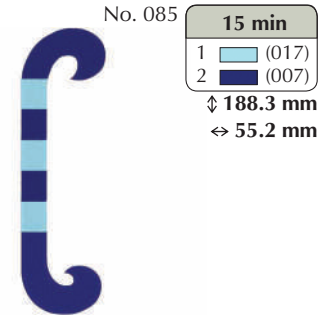
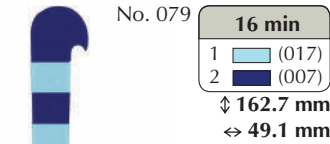
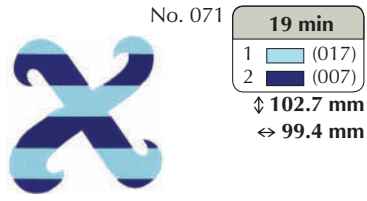
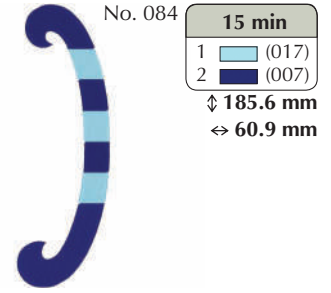
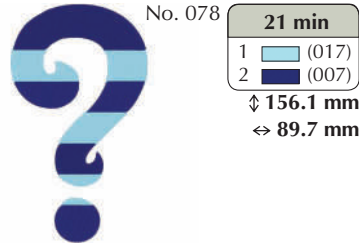
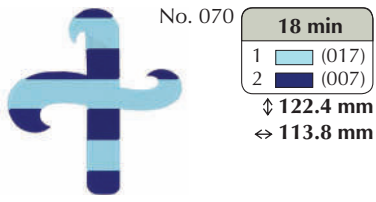

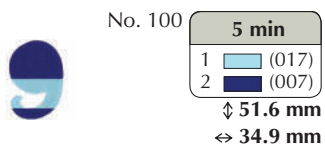
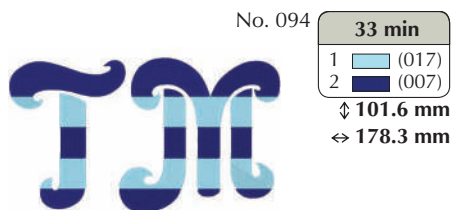
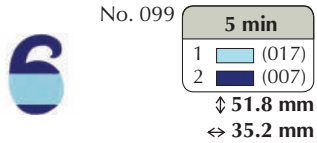
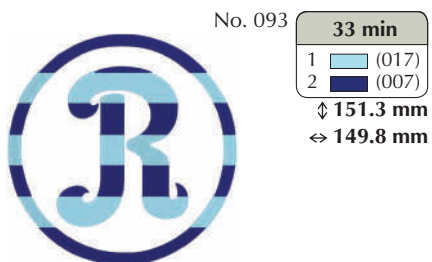
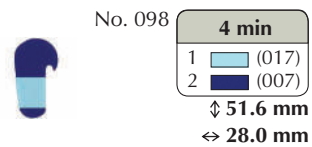
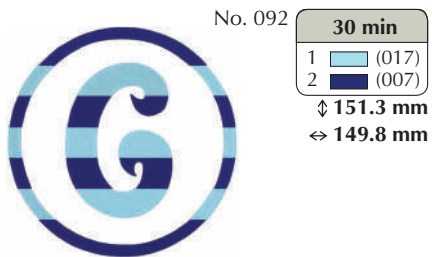
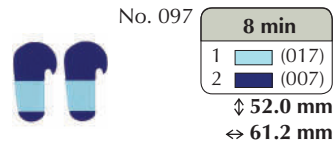
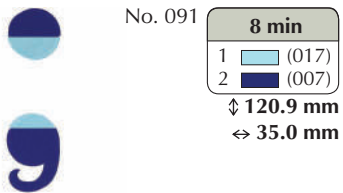
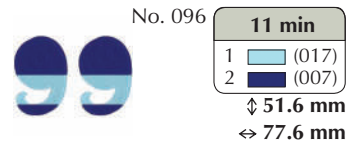
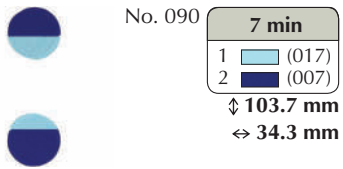
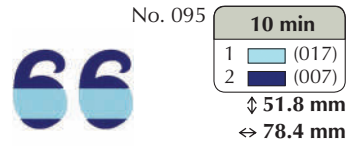

- Greek Alphabet
- Motifs alphabet grec
- Alfabeto greco
- Alfabeto grego

- Buchstabenmuster des griechischen Alphabets
- Grieks alfabet
- Costuras de caracteres alfabéticos griegos
- Греческий шрифт



	No. 001 4 min 1 (209) 2 (513) 3 (405) ↓ 55.7 mm ↔ 57.2 mm		No. 009 3 min 1 (209) 2 (513) 3 (405) ↓ 54.1 mm ↔ 27.0 mm		No. 017 5 min 1 (209) 2 (513) 3 (405) ↓ 54.4 mm ↔ 44.3 mm
	No. 002 6 min 1 (209) 2 (513) 3 (405) ↓ 54.3 mm ↔ 50.5 mm		No. 010 5 min 1 (209) 2 (513) 3 (405) ↓ 54.1 mm ↔ 57.4 mm		No. 018 5 min 1 (209) 2 (513) 3 (405) ↓ 54.1 mm ↔ 49.2 mm
	No. 003 4 min 1 (209) 2 (513) 3 (405) ↓ 54.2 mm ↔ 48.4 mm		No. 011 4 min 1 (209) 2 (513) 3 (405) ↓ 55.7 mm ↔ 54.3 mm		No. 019 4 min 1 (209) 2 (513) 3 (405) ↓ 54.1 mm ↔ 48.1 mm
	No. 004 5 min 1 (209) 2 (513) 3 (405) ↓ 55.6 mm ↔ 49.8 mm		No. 012 6 min 1 (209) 2 (513) 3 (405) ↓ 54.3 mm ↔ 68.0 mm		No. 020 4 min 1 (209) 2 (513) 3 (405) ↓ 53.9 mm ↔ 56.2 mm
	No. 005 4 min 1 (209) 2 (513) 3 (405) ↓ 54.1 mm ↔ 49.7 mm		No. 013 5 min 1 (209) 2 (513) 3 (405) ↓ 55.6 mm ↔ 55.6 mm		No. 021 7 min 1 (209) 2 (513) 3 (405) ↓ 54.3 mm ↔ 55.6 mm
	No. 006 4 min 1 (209) 2 (513) 3 (405) ↓ 53.9 mm ↔ 47.5 mm		No. 014 7 min 1 (209) 2 (513) 3 (405) ↓ 54.1 mm ↔ 48.7 mm		No. 022 5 min 1 (209) 2 (513) 3 (405) ↓ 54.1 mm ↔ 57.2 mm
	No. 007 5 min 1 (209) 2 (513) 3 (405) ↓ 54.2 mm ↔ 55.8 mm		No. 015 5 min 1 (209) 2 (513) 3 (405) ↓ 56.8 mm ↔ 52.7 mm		No. 023 6 min 1 (209) 2 (513) 3 (405) ↓ 54.3 mm ↔ 61.9 mm
	No. 008 7 min 1 (209) 2 (513) 3 (405) ↓ 56.8 mm ↔ 52.5 mm		No. 016 5 min 1 (209) 2 (513) 3 (405) ↓ 54.1 mm ↔ 58.9 mm		No. 024 6 min 1 (209) 2 (513) 3 (405) ↓ 55.9 mm ↔ 53.2 mm

- Appliqué Greek Alphabet
- Alphabet grec Appliqué
- Alfabeto greco in appliqué
- Alfabeto grego para apliques

- Griechische Buchstaben für Applikationen
- Applicatie Grieks alfabet
- Alfabeto griego con adornos
- Греческий шрифт для аппликации

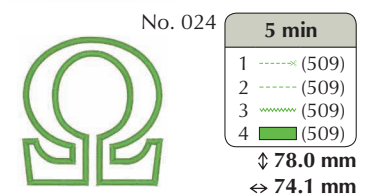
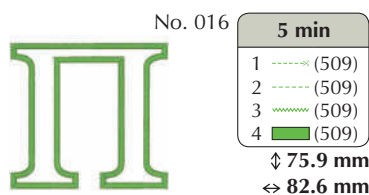
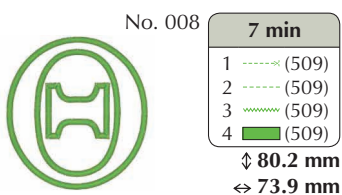
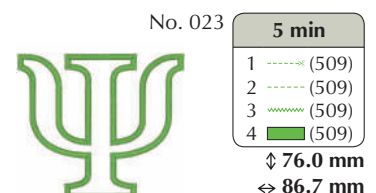
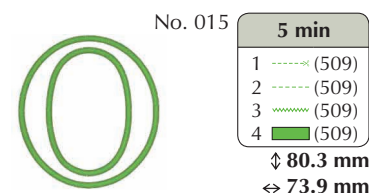
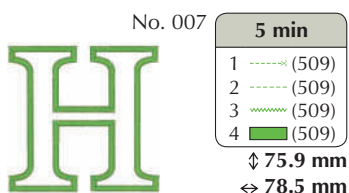
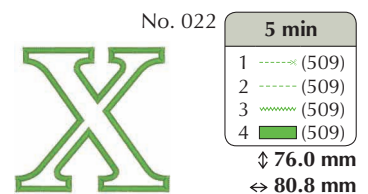
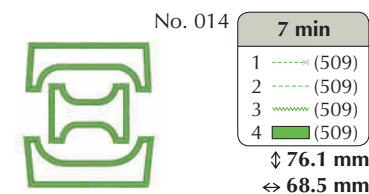
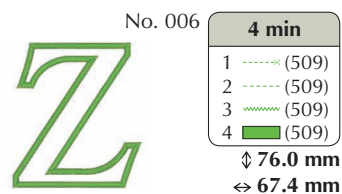
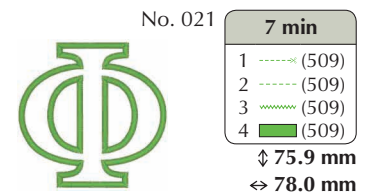
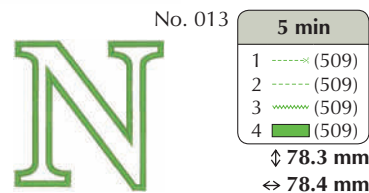
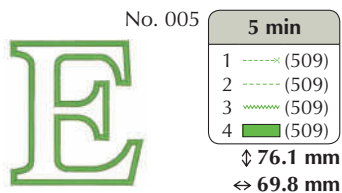
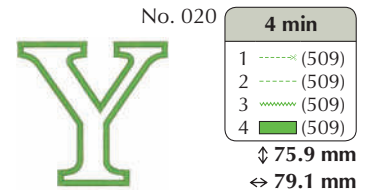
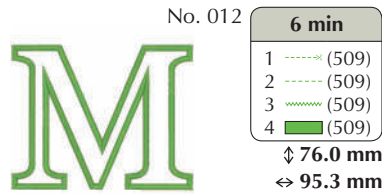
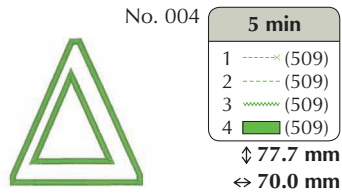
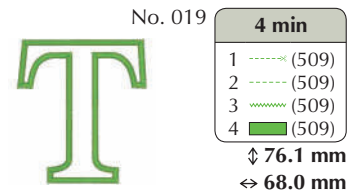
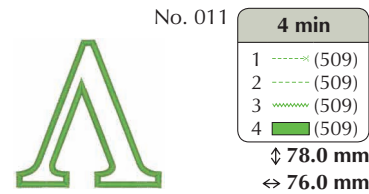
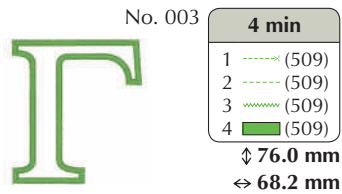
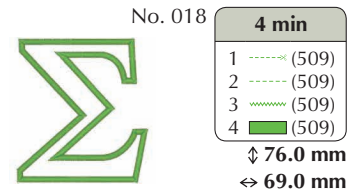
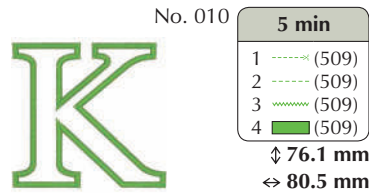
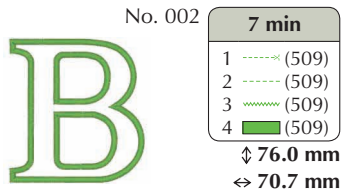
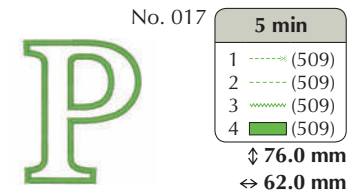
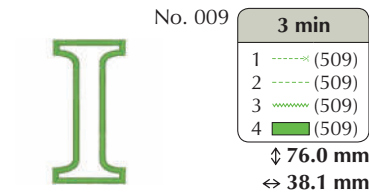
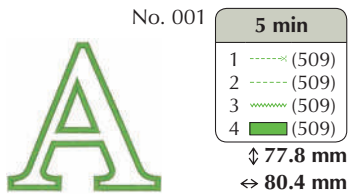

Refer to the operation manual for the embroidery machine for details on how to embroider appliqués.
 Weitere Hinweise zum Sticken von Applikationen finden Sie in der Bedienungsanleitung der Stickmaschine.
 Reportez-vous au manuel d'instructions de la machine à broder pour plus d'informations sur la broderie des appliqués.
 Raadpleeg de bedieningshandleiding bij de borduurmachine voor gedetailleerde uitleg over het borduren van applicaties.
 Consultare il manuale di istruzioni della macchina per ricamare per i dettagli relativi al ricamo in appliqué.
 Consulte el manual de instrucciones de la máquina de bordar si desea más información sobre cómo bordar apliques.
 Consulte o manual de operações da máquina de bordar para obter detalhes sobre como bordar apliques.
 Инструкции по вышиванию аппликаций приведены в руководстве пользователя машины.

Examples of Combinations
 Exemples de combinaisons
 Esempi di combinazioni
 Exemplos de combinações

Kombinationsbeispiele
 Voorbeelden van combinaties
 Ejemplos de combinaciones
 Примеры использования

- Embroidery patterns on these pages are illustration images, which may be different from the patterns in your machine.
- Les motifs de broderie figurant sur ces pages sont des images d'illustration qui peuvent différer des motifs proposés par votre machine.
- I ricami di queste pagine sono immagini a scopo illustrativo, che potrebbero differire dai ricami della macchina.
- Os padrões de bordado nestas páginas são imagens ilustrativas, que podem ser diferentes dos padrões em sua máquina.

- Die auf diesen Seiten abgebildeten Stickmuster dienen nur der Illustration; sie können von den Mustern in Ihrer Maschine abweichen.
- De weergegeven borduurpatronen in deze illustraties dienen als voorbeeld. Het is mogelijk dat ze af wijken van de borduurpatronen in de machine.
- Los diseños de bordado de estas páginas son ilustraciones, que pueden ser diferentes de los diseños de la máquina.
- Дизайны для вышивания на этих страницах приведены для иллюстрации и могут отличаться от дизайнов в вашей вышивальной машине.



 No.012, No.013 x 4, No.014



 No.043



 No.045, No.046

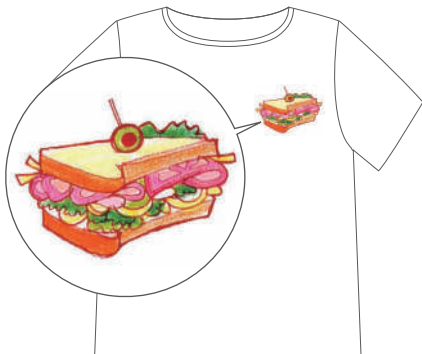

 No.039



 No.018



 No.015 x 3, No.016 x 2



 No.021



 No.023

Combinations

Broaden your embroidering world by combining the patterns

Combinaisons

Élargissez votre univers de broderie en combinant les motifs

Combinazioni

Per ampliare il proprio universo del ricamo attraverso la combinazione di vari ricami

Combinações

Amplie seu universo de bordar através da combinação de padrões

Kombinationen

Erweitern Sie Ihre Stickereiwelt durch Kombinieren von Mustern

Combinaties

Verbreed uw borduurmogelijkheden door de patronen te combineren

Combinaciones

Amplie las posibilidades de bordado mediante la combinación de diseños

Комбинации

Расширьте возможности творчества благодаря комбинированию рисунков



 No.039

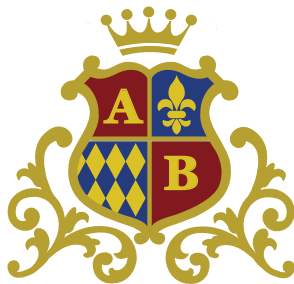

 No.040



 No.003, No.005 x 10



 No.038



 No.039



 No.033, No.034



 No.003, No.004,
No.005, No.006

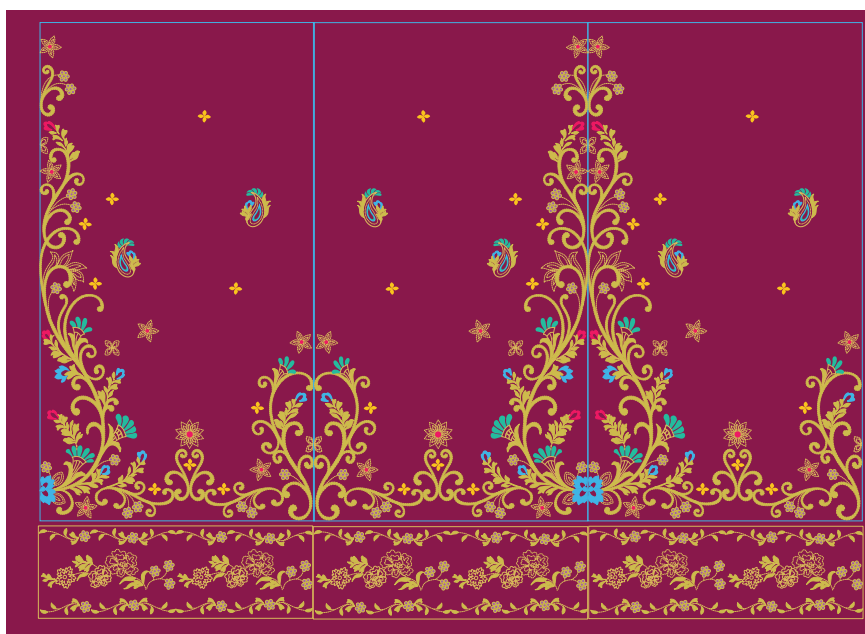

 No.029 x 3, No.030 x 12, No.031 x 6

Embroidering on caps

The optional wide cap frame enables you to embroider up to 360 mm x 60 mm (14 inches x 2-3/8 inches) size of embroidery patterns on caps.

Broderie sur casquettes

Le cadre pour casquettes grand format en option vous permet de broder des motifs d'une taille maximale de 360 x 60 mm (14 x 2-3/8 pouces) sur des casquettes.

Ricamo su cappelli

Il telaio per cappelli grande opzionale consente di eseguire ricami fino a 360 mm x 60 mm (14 pollici x 2-3/8 pollici) sui cappelli.

Bordado em bonés

O bastidor de boné amplo opcional permite bordar até um tamanho de 360 mm x 60 mm (14 polegadas x 2-3/8 polegadas) de padrões de bordado em bonés.

Sticken auf Kappen

Mit dem optionalen breiten Kappenrahmen können Sie bis zu 360 x 60mm (14 x 2-3/8 Zoll) große Stickdesigns auf Kappen sticken.

Borduren op petten

Met het optioneel verkrijgbare grotere pettenframe, kunt u borduurmotieven met een afmeting van 360 mm x 60 mm (14 inch x 2-3/8 inch) borduren op petten.

Bordado en gorras

El bastidor ancho para gorras opcional permite bordar diseños de un tamaño máximo de 360 mm x 60 mm (14 pulgadas x 2-3/8 pulgadas) en gorras.

Вышивание на бейсболках

Дополнительное широкое устройство для вышивания бейсболки позволяет вышивать на бейсболках дизайны размером до 360 мм x 60 мм (14 дюймов x 2-3/8 дюймов).



No.022



No.019

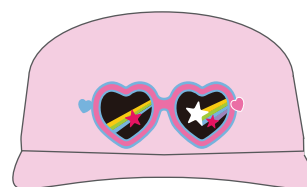

No.020



No.018

Even if you don't have the wide cap frame, you can enjoy embroidering using optional cap frames. Various embroidery designs help you to create your original caps.

Auch ohne den breiten Kappenrahmen können Sie mit optionalen Kappenrahmen

viel Freude beim Stickten haben. Verschiedene Stickdesigns helfen Ihnen dabei, Ihre ganz individuellen Kappen herzustellen.

Même si vous ne possédez pas le cadre pour casquettes grand format, vous pouvez toutefois broder en utilisant un cadre pour casquettes en option. Vous pouvez créer vos propres casquettes originales grâce à des motifs de broderie variés.

Ook als u niet in het bezit bent van het grotere pettenframe, zijn er optionele pettenframes verkrijgbaar.

Met de verschillende borduurmotieven kunt u uw eigen originele petten ontwerpen.

Anche se non si dispone di un telaio per cappelli grande, è possibile ricamare utilizzando i telai per cappelli opzionali. I vari tipi di ricami disponibili consentono di creare cappelli originali.

Incluso si no dispone del bastidor ancho para gorras, puede disfrutar bordando con los bastidores para gorras opcionales. Diversos diseños de bordado le ayudarán a crear originales gorras.

Mesmo se não tiver o bastidor de boné amplo, você poderá bordar utilizando os bastidores de boné opcional. Vários desenhos de bordado ajudam você a criar bonés originais.

Даже если у вас нет широкого устройства для вышивания бейсболки, вы можете делать красивые вышивки при помощи обычных устройств для вышивания бейсболки (опция). Широкий выбор дизайнов для вышивания поможет сделать ваши бейсболки оригинальными и неповторимыми.

Specialty stabilizers create 3-D embroidery

Spezial-Unterlegmaterial zum Kreieren von 3-D-Stickerei

Des stabilisateurs spéciaux permettent de créer des broderies 3D

Speciale steunstof voor 3-D-borduurwerk

Materiali specifici consentono di creare ricami 3D

Estabilizadores especiales crean bordado con aspecto tridimensional

Estabilizadores especiais criam um bordado 3D

Специальные стабилизаторы для создания 3D вышивок



No.019

Embroidering large patterns

You can embroider up to 360 mm × 360 mm (14 inches × 14 inches) size embroidery pattern using the optional jumbo frame.

Simply embroider the first half of the design, turn the hoop 180 degrees and embroider the second half of the design.

Large patterns (up to 350 mm × 350 mm (13-3/4 inches × 13-3/4 inches) size embroidery) for the optional jumbo frame can be created by using the embroidery editing software version PE-DESIGN NEXT or later.

Some sample patterns are included in PE-DESIGN NEXT.

Motifs de broderie grand format

Vous pouvez broder des motifs d'une taille maximale de 360 × 360 mm (14 × 14 pouces) à l'aide du cadre Jumbo en option.

Brodez la première moitié du motif, tournez le cadre de 180 degrés et brodez la seconde moitié du motif.

Vous pouvez créer de grands motifs (jusqu'à 350 × 350 mm (13-3/4 × 13-3/4 po)) pour le cadre Jumbo en option à l'aide du logiciel d'édition de broderie PE-DESIGN NEXT ou version ultérieure. Des exemples de motifs sont inclus dans PE-DESIGN NEXT.

Ricami di grandi dimensioni

È possibile eseguire ricami fino a 360 mm × 360 mm (14 pollici × 14 pollici) con l'utilizzo del maxi telaio opzionale.

Ricamare semplicemente la prima parte del ricamo, ruotare il telaio di 180 gradi e ricamare la seconda metà del ricamo.

È possibile creare ricami di grandi dimensioni fino a 350 mm × 350 mm (13-3/4 pollici × 13-3/4 pollici) per il maxi telaio opzionale utilizzando il software di modifica ricamo versione PE-DESIGN NEXT o successiva.

In PE-DESIGN NEXT sono inclusi alcuni ricami di esempio.

Bordar padrões grandes

É possível bordar um tamanho de até 360 mm × 360 mm (14 polegadas × 14 polegadas) de padrão de bordado utilizando o moldura jumbo opcional.

Basta bordar a primeira metade do design, girar o aro 180 graus e bordar a segunda metade do desenho.

Padrões grandes (até 350 mm × 350 mm (13-3/4 polegadas × 13-3/4 polegadas) tamanho do bordado) para que a moldura jumbo opcional possa ser criada usando a versão do software de edição de bordados PE-DESIGN NEXT ou posterior.

Alguns padrões de amostra estão incluídos no PE-DESIGN NEXT.

Sticken von großen Mustern

Mit dem optionalen Jumbo-Rahmen können Sie bis zu 360 × 360 mm (14 × 14 Zoll) große Stickmuster sticken.

Stickern Sie einfach die erste Hälfte des Designs, drehen den Stickrahmen um 180 Grad und sticken Sie dann die zweite Hälfte des Designs.

Große Stickereien (bis zu 350 × 350 mm (13-3/4 × 13-3/4 Zoll)) für den optionalen Jumbo-Rahmen können Sie mit dem Stickdesignbearbeitungsprogramm der Version PE-DESIGN NEXT oder höher kreieren.

In PE-DESIGN NEXT sind einige Beispiel-Stickdesigns enthalten.

Grote patronen borduren

U kunt patronen van maar liefst 360 mm × 360 mm (14 inch × 14 inch) borduren met het optionele Jumboframe.

Borduur de eerste helft van het ontwerp, draai het raam 180 graden en borduur vervolgens de tweede helft.

Grote borduurpatronen (max. 350 mm × 350 mm (13-3/4 inch × 13-3/4 inch)) voor het optionele Jumboframe kunt u maken met de borduursoftware PE-DESIGN NEXT of een recentere programmaversie. In PE-DESIGN NEXT zijn enkele voorbeeldpatronen inbegrepen.

Bordado de diseños de gran tamaño

Puede bordar diseños de un tamaño máximo de 360 mm × 360 mm (14 pulgadas × 14 pulgadas) con el bastidor jumbo opcional.

Simplemente borde la primera mitad del diseño, gire el bastidor 180 grados y borde la segunda mitad del diseño.

Pueden crearse patrones de gran tamaño (bordado de hasta 350 mm × 350 mm (13-3/4 pulg. × 13-3/4 pulg.)) para el bastidor jumbo opcional utilizando el software de edición de bordados versión PE-DESIGN NEXT o posterior.

En PE-DESIGN NEXT se incluyen algunos patrones de muestra.

Вышивание больших дизайнов

При помощи дополнительных пялец Jumbo можно вышивать дизайны размером до 360 мм × 360 мм (14 дюймов × 14 дюймов).

Вышейте первую половину дизайна, разверните пяльцы на 180 градусов и вышейте вторую половину дизайна.

Большие дизайны (с размерами вышивки до 350 мм × 350 мм (13-3/4 дюймов × 13-3/4 дюймов)) для дополнительных пялец Jumbo можно создавать с помощью программы редактирования вышивок PE-DESIGN NEXT или более поздней версии.

Образцы некоторых дизайнов уже включены в программу PE-DESIGN NEXT.

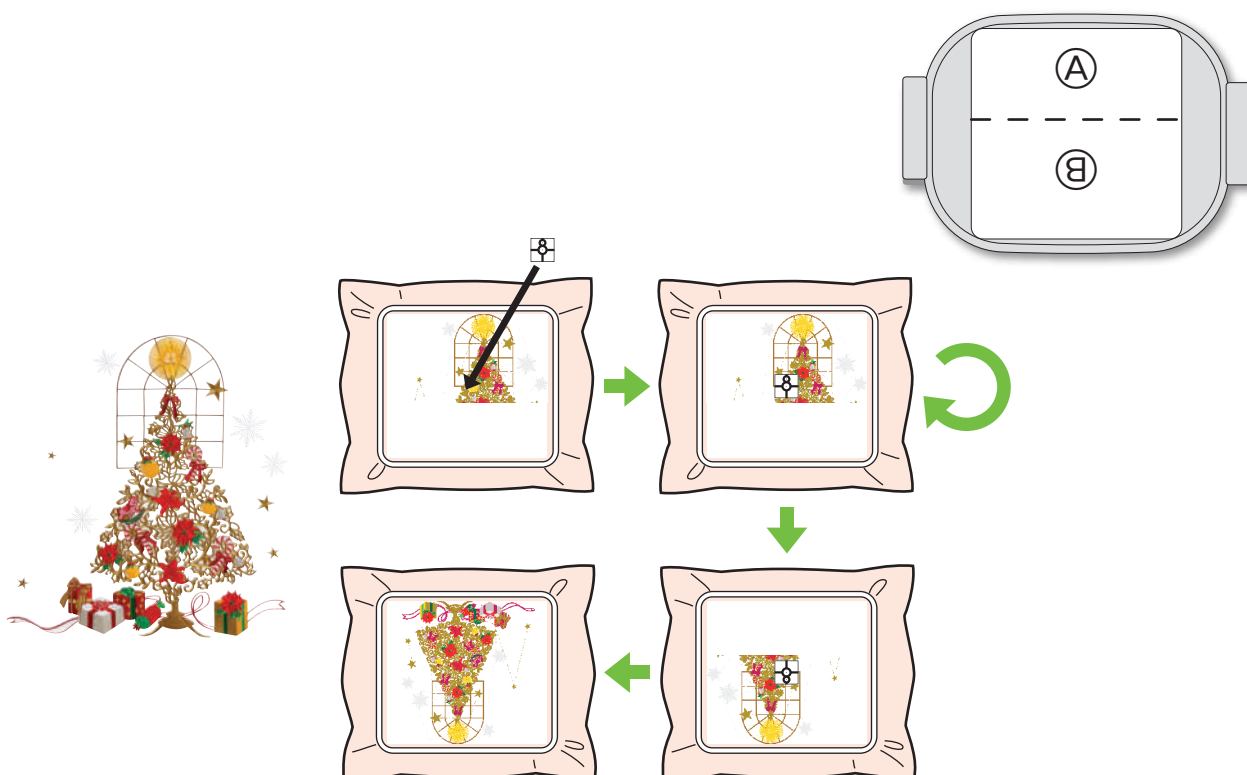

Embroidering quilt patterns

The optional quilt frame and magnetic sash frame are best for embroidering quilt pieces of your favorite designs. The magnetic sash frame makes it easier to rehoop the fabric without removing the frame from the machine.

Broderie de motifs à quilter

Le cadre pour quilting et le cadre à broder magnétique en option sont parfaits pour broder des pièces pour quilting de vos motifs préférés. Le cadre à broder magnétique permet de remettre facilement le tissu en place sans retirer le cadre de la machine.

Trapuntatura

Il telaio per trapuntatura e il telaio magnetico opzionali sono i migliori per cucire blocchi patchwork con i propri ricami preferiti. Il telaio magnetico semplifica il reinserimento del tessuto senza dover rimuovere il telaio dalla macchina.

Bordar padrões de acolchoados

O bastidor de acolchoado e o bastidor magnético para acolchoados opcionais são perfeitos para bordar peças acolchoadas com seus desenhos favoritos. O bastidor magnético para acolchoados facilita a recolocação do tecido sem remover o bastidor da máquina.

Sticken von Quilt-Mustern

Der optionale Quiltrahmen und der Magnetrahmen eignen sich am besten zum Besticken von Quiltteilen mit Ihren Lieblingsstickmustern. Mit dem Magnetrahmen mit Einzelmagneten können Sie den Stoff einfach umspannen, ohne den Rahmen aus der Maschine zu nehmen.

Quiltpatronen borduren

Het optionele quiltraam en het magneetframe zijn het geschiktst om quiltstukken met uw favoriete ontwerp te borduren. Het magneetframe vergemakkelijkt het opnieuw spannen van de stof zonder het frame los te maken van de machine.

Bordado de diseños de acolchado

El bastidor de acolchado opcional y el bastidor magnético son los más apropiados para bordar acolchados de sus diseños favoritos. El bastidor magnético hace que resulte más sencillo volver a colocar el tejido sin retirar el bastidor de la máquina.

Вышивание дизайнов для квилтинга

Дополнительные пяльцы для квилтинга и пяльцы с магнитными зажимами идеально подходят для вышивания любимых дизайнов для квилтинга. В пяльцах с магнитными зажимами можно легко закрепить ткань повторно, не снимая их с машины.

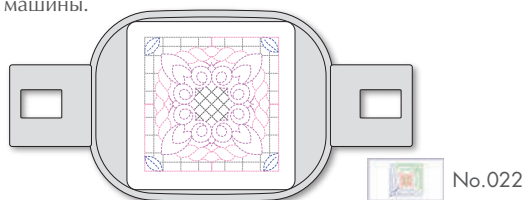

- Examples of combining patterns using the optional quilt frame
- Exemples de combinaisons de motifs avec le cadre pour quilting en option
- Esempi di combinazioni di ricami utilizzando il telaio per trapuntatura opzionale
- Exemplos de combinação de padrões usando o bastidor de acolchoado opcional

- Beispiele zum Kombinieren von Mustern mit dem optionalen Quiltrahmen
- Voorbeelden van patrooncombinaties met gebruik van het optionele quiltraam
- Ejemplos de combinación de patrones utilizando el bastidor de acolchado opcional
- Примеры комбинирования дизайнов с использованием дополнительных пялец для квилтинга

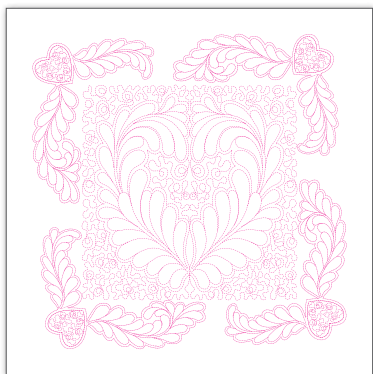

No.011 x 2, No.012 x 4

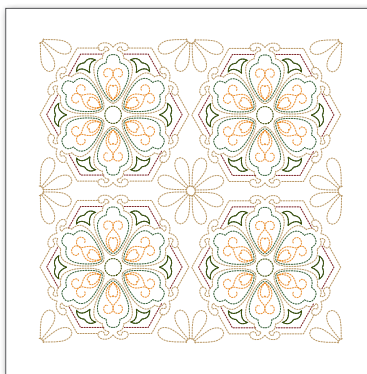

No.016 x 4

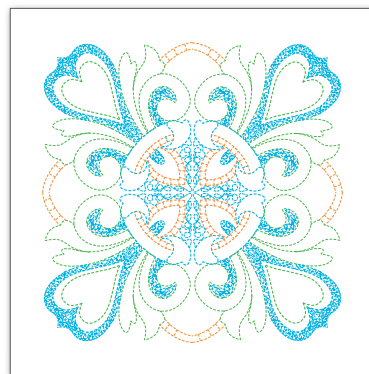

No.020 x 4

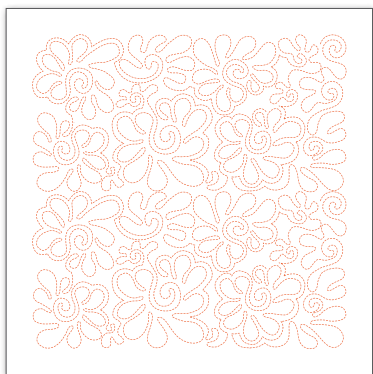

No.013 x 2

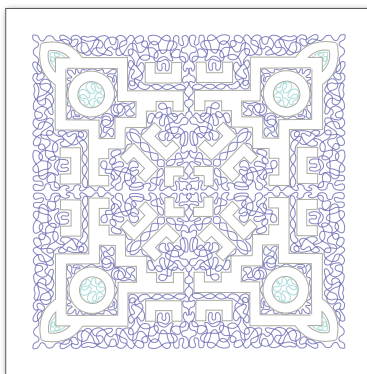

No.006 x 4

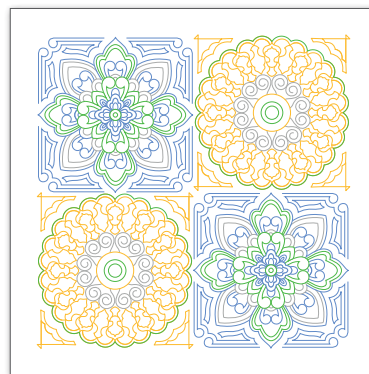

No.007 x 2, No.008 x 2

•Examples of combining patterns using the optional magnetic sash frame

•Exemples de combinaisons de motifs avec le cadre à broder magnétique en option

•Esempi di combinazioni di ricami usando il telaio magnetico opzionale

•Exemplos de combinação de padrões usando o bastidor magnético para acolchoados opcional

•XBeispiele zum Kombinieren von Mustern mit dem optionalen Magnetrahmen mit Einzelmagneten

•Voorbeelden van patrooncombinaties met gebruik van het optionele magneetframe

•Ejemplos de combinación de patrones utilizando el bastidor magnético opcional

•Примеры комбинирования дизайнов с использованием дополнительных пялец с магнитными зажимами

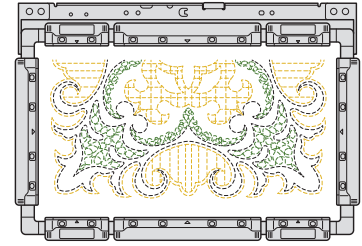

 No.001

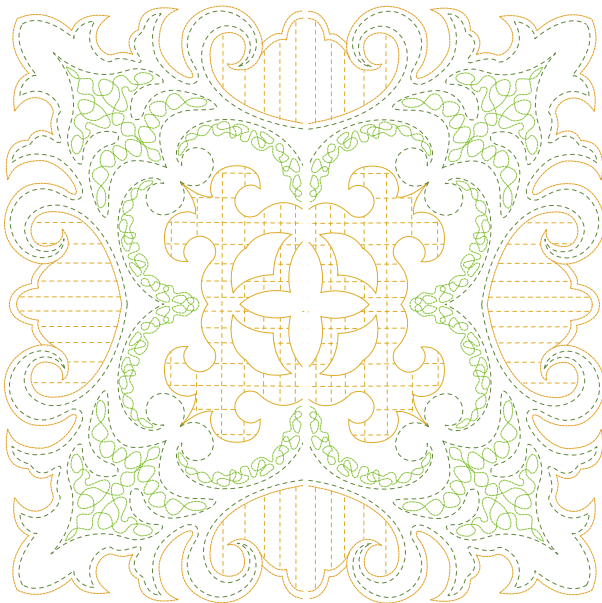

 No.001 x 2

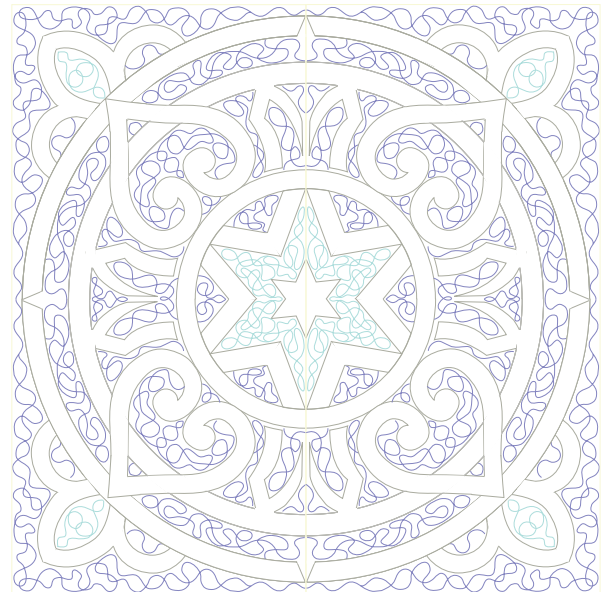

 No.004 x 2

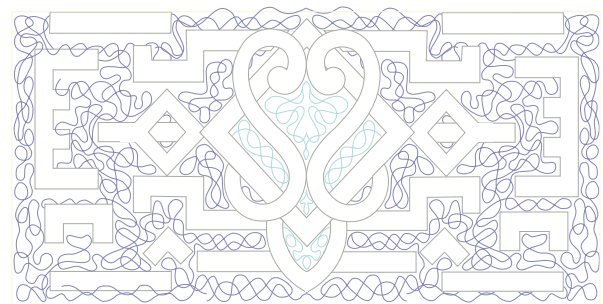

 No.005

Embroidering repeated patterns

The optional border frame and magnetic sash frame help you to embroider repeated patterns. They make it easier to rehoop the fabric without removing the frames from the machine.

Broderie de motifs répétitifs

Le cadre à bordure et le cadre à broder magnétique en option vous permettent de broder des motifs répétitifs. Ils permettent de remettre facilement le tissu en place sans retirer les cadres de la machine.

Ricamo di bordi in continuo

Il telaio per bordi e il telaio magnetico opzionali aiutano a cucire ricami ripetuti. Semplificano il reinserimento del tessuto senza dover rimuovere i telai dalla macchina.

Bordado de desenhos repetidos

O bastidor de arremate opcional e o bastidor magnético para acolchoados ajudam a bordar padrões repetitivos. Eles facilitam a recolocação do tecido sem remover os bastidores da máquina.

Sticken von wiederholten Mustern

Der optionale Randmuster-Stickrahmen und der optionale Magnetrahmen mit Einzelmagneten helfen Ihnen dabei, sich wiederholende Muster zu sticken. Mit ihnen können Sie den Stoff einfach umspannen, ohne die Rahmen aus der Maschine zu nehmen.

Herhaalpatronen borduren

Met het optionele borduurraam en het magneetframe kunt u herhaalpatronen borduren. Raam en frame vergemakkelijken het opnieuw spannen van de stof zonder raam of frame los te maken van de machine.

Bordado de diseños repetidos

El bastidor de bordes opcional y el bastidor magnético ayudan a bordar patrones repetidos. Hacen que resulte más sencillo volver a colocar el tejido sin retirar los bastidores de la máquina.

Вышивание повторяющихся дизайнов

Дополнительные бордюрные пальцы и пальцы с магнитными зажимами позволяют вышивать повторяющиеся дизайны. В них можно легко повторно закреплять ткань, не снимая пальцы с машины.



- Examples of combining patterns using the optional border frame
- Exemples de combinaisons de motifs avec le cadre à bordure en option
- Esempi di combinazioni di ricami utilizzando il telaio per bordi opzionale
- Exemplos de combinação de padrões usando o bastidor de arremate opcional

- Beispiele zum Kombinieren von Mustern mit dem optionalen Randmuster-Stickrahmen
- Voorbeelden van patrooncombinaties met gebruik van het optionele randborduurraam
- Ejemplos de combinación de patrones utilizando el bastidor de bordes opcional
- Примеры комбинирования дизайнов с использованием дополнительных бордюрных пальцев

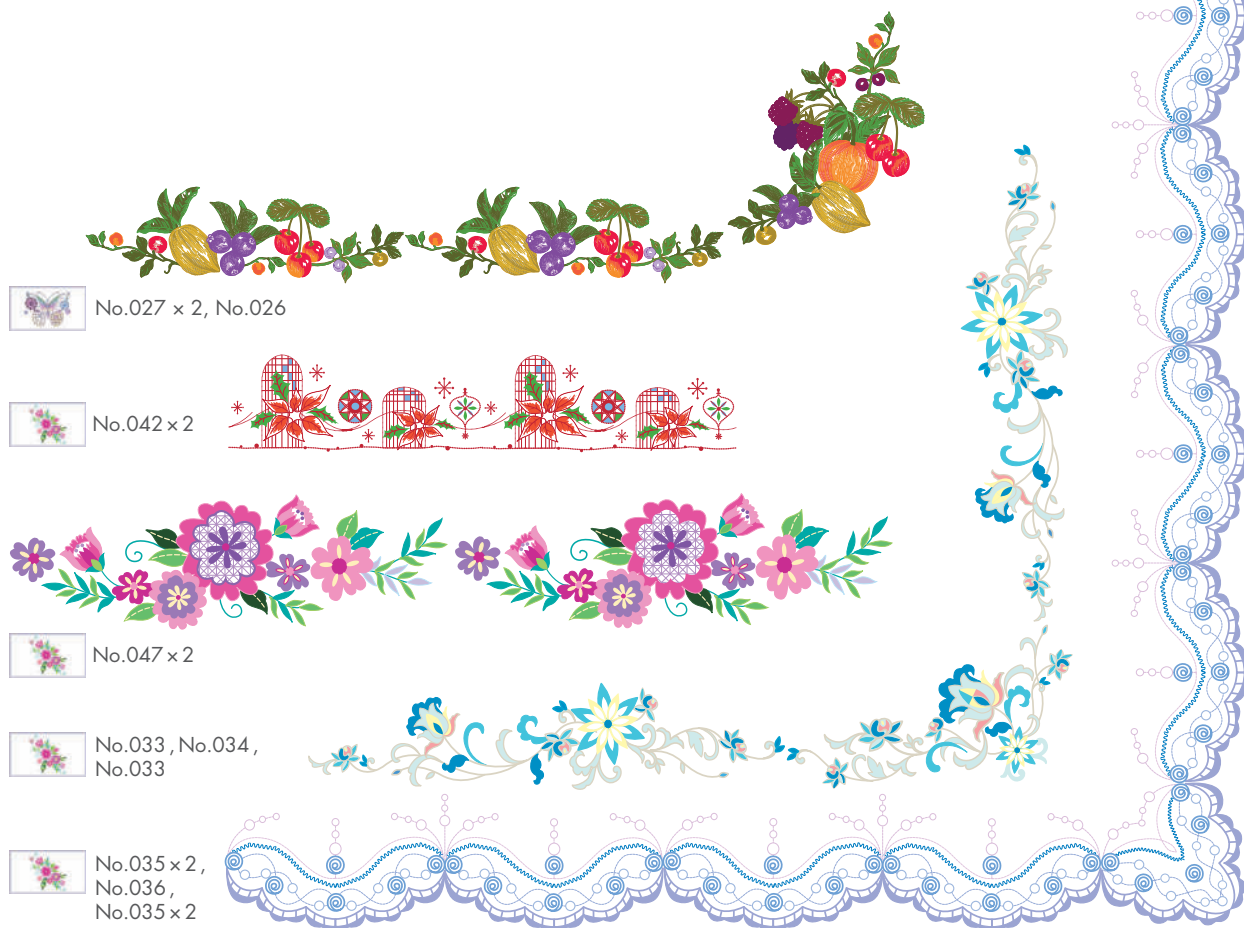

- Examples of combining patterns using the optional magnetic sash frame
- Exemples de combinaisons de motifs avec le cadre à broder magnétique en option
- Esempi di combinazioni di ricami utilizzando il telaio magnetico opzionale
- Exemplos de combinação de padrões usando o bastidor magnético para acolchoados opcional

- Beispiele zum Kombinieren von Mustern mit dem optionalen Magnetrahmen mit Einzelmagneten
- Voorbeelden van patrooncombinaties met gebruik van het optionele magneetframe
- Ejemplos de combinación de patrones utilizando el bastidor magnético opcional
- Примеры комбинирования дизайнов с использованием дополнительных пялец с магнитными зажимами

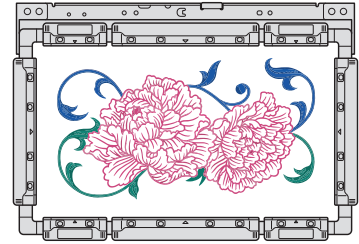

 No.004



 No.004 x 3

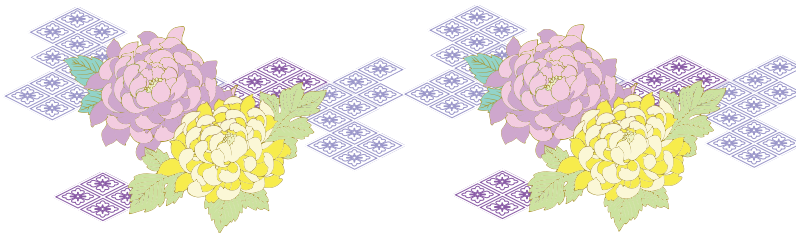

 No.007 x 2

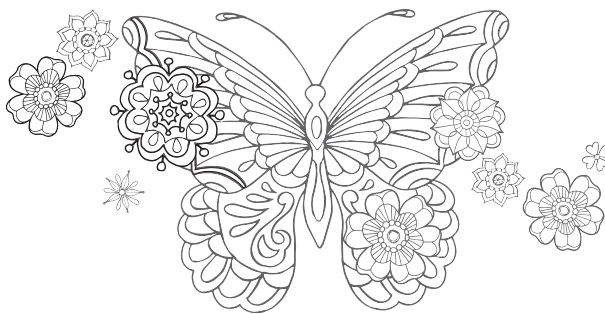

 No.009, No.010

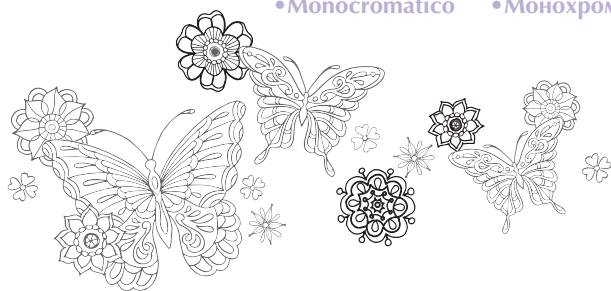

- Monochrome
- Monochrome
- Monocromo
- Monocromático
- Monochrom
- Monochroom
- Monocromo
- Монохром



 No.009, No.010



- Color
- Couleur
- Colore
- Cor
- Farbe
- Kleur
- Color
- Цвет

Font Name Chart
 Tableau des noms de polices
 Tabella nomi dei font
 Quadro de nomes de fontes

Tabelle der Schriftarten
 Overzicht lettertypen
 Diagrama de nombre de las fuentes
 Таблица названий шрифтов

	Font Key/ Schriftarttaste/ Touche de police/ Lettertypetoets/ Tasto font/ Clave de las fuentes/ Tecla da fonte/ Кнопка шрифта	Font Name/ Schriftartname/ Nom de la police/ Lettertype/ Nome font/ Nombre de la fuente/ Nome da fonte/ Название шрифта
1	⁰⁰ 	Künstlerschreibschrift
2	⁰¹ 	Block 01
3	⁰² 	Block 02
4	⁰³ 	Alaska
5	⁰⁴ 	Serif 01
6	⁰⁵ 	Serif 03
7	⁰⁶ 	Brussels Demi Outline
8	⁰⁷ 	Tennessee ExtraBold
9	⁰⁸ 	Serif 02
10	⁰⁹ 	Script 01
11	¹⁰ 	Calgary Mediumitaric
12	¹¹ 	Bermuda Script
13	¹² 	Sicilia Light Italic (Sicilia)
14	¹³ 	Kingston Regular
15	¹⁴ 	Luedickital
16	¹⁵ 	Toms Handwritten
17	¹⁶ 	Brunei
18	¹⁷ 	Block 03
19	¹⁸ 	Istanbul

	Font Key/ Schriftarttaste/ Touche de police/ Lettertypetoets/ Tasto font/ Clave de las fuentes/ Tecla da fonte/ Кнопка шрифта	Font Name/ Schriftartname/ Nom de la police/ Lettertype/ Nome font/ Nombre de la fuente/ Nome da fonte/ Название шрифта
20		Los Angeles
21		San Diego
22		Saipan
23		Cairo
24		Gothic 01
25		Germany
26		Sofia Bold
27		Utah Bold Cyrillic
28		PC Tennessee Bold Cyrillic
29		Helsinki Nallow S
30		Antique Oakland S
31		Riesa S
32		Germany S
33		Script 01 SR
34		Block 01 (Small font)
35		Japanese Font 1/ Japanische Schriftart 1/ Police japonaise 1/ Japans lettertype 1/ Font giapponese 1/ Fuente japonesa 1/ Fonte japonesa 1/ Японский шрифт 1 (Misugi Gothic B)
36		Japanese Font 2/ Japanische Schriftart 2/ Police japonaise 2/ Japans lettertype 2/ Font giapponese 2/ Fuente japonesa 2/ Fonte japonesa 2/ Японский шрифт 2
37		Japanese Font 3/ Japanische Schriftart 3/ Police japonaise 3/ Japans lettertype 3/ Font giapponese 3/ Fuente japonesa 3/ Fonte japonesa 3/ Японский шрифт 3 (Rakuchiku POP H)

English
German
French
Dutch
Italian
Spanish
Portuguese-BR
Russian

884-T15



XH5054-001